

- A) Forare il cartongesso a seconda delle misure del prodotto.
A) Cut the plasterboard according to the size of the product.

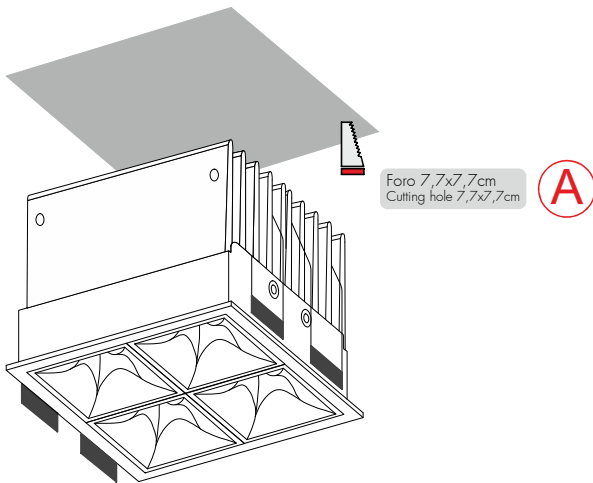

- B) Effettuare il collegamento elettrico.
B) Make the electrical connection.

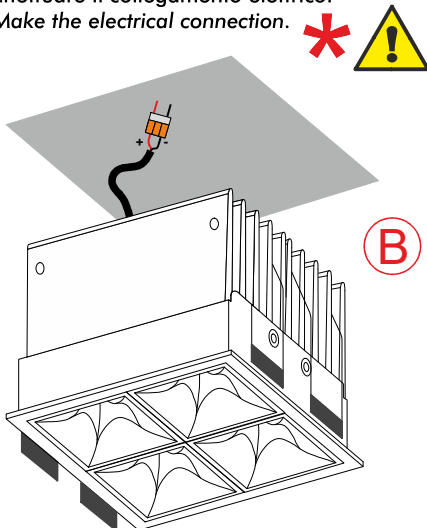

- C) Sollevare le molle e inserire il prodotto nel cartongesso.
C) Lift the springs and insert the product into the plasterboard.

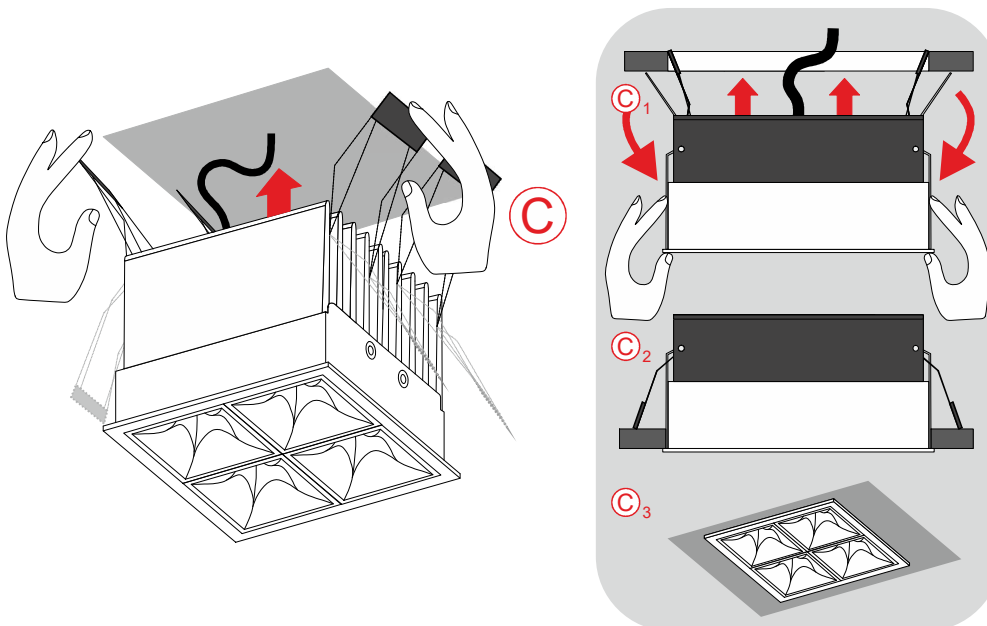

PRODOTTO / PRODUCT

Task

MONTAGGIO / MOUNTING

Incasso/Recessed

CODICI / CODES

4048D

n°INSTALLATORI / INSTALLERS n°



STRUMENTI / INSTRUMENTS

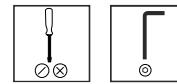

TEMPO / TIME



CERTIFICAZIONI / CERTIFICATIONS



ATTENZIONE / CAUTION



Togliere la rete di alimentazione prima dell'installazione, sostituzione della lampada e comunque prima di ogni operazione di manutenzione.

Always turn off the power supply before installing, the replacement of the light bulb and to any maintenance intervention.



La sicurezza dell'apparecchio è garantita solo con l'uso appropriato delle seguenti istruzioni; pertanto è necessario consultarle e conservarle.

The safety of this product is guaranteed only if correctly used, according to this instruction sheet, which must be read first

COLLEGAMENTO ELETTRICO * ELECTRICAL CONNECTION



Attenzione! Togliere la rete di alimentazione prima dell'installazione, sostituzione della lampada e comunque prima di ogni operazione di manutenzione.

Caution! Always turn off power supply before install, replacing of the light bulb and prior to any maintenance interventions.

Versione ONOFF ONOFF Version

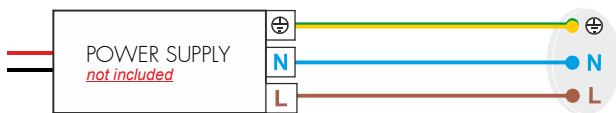

Versione dimmerabile - Collegamento con pulsante Dimmable Version - Touch-DIM wiring

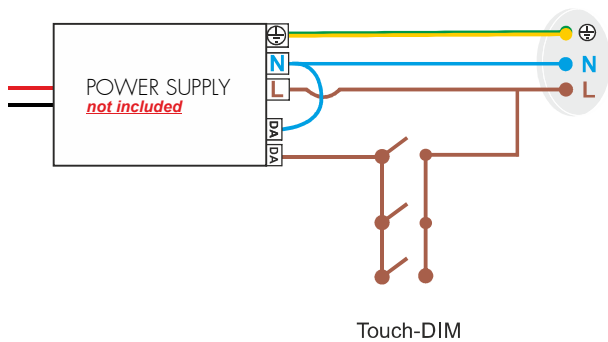

Versione dimmerabile - Collegamento con sistema di gestione Dimmable Version - Management System wiring

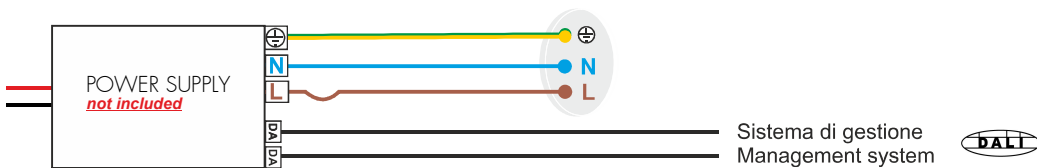

Versione TAGLIO DI FASE

