

## ISTRUZIONI DI MONTAGGIO

### ASSEMBLY INSTRUCTIONS

- 1) Rimuovere il diffusore
- 1) Remove the diffuser

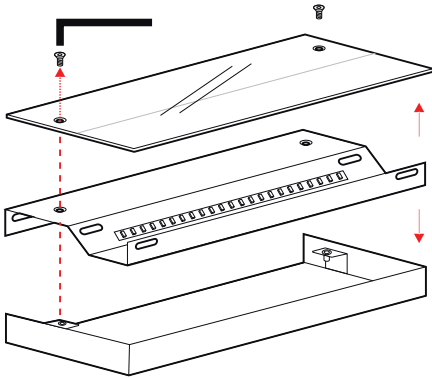

- 2) Fissare la base alla parete con tasselli adeguati al supporto **prestare attenzione a non danneggiare il LED con il cacciavite**
- 2) Attach the base to the wall with adequate **support anchors** **be careful not to damage the LED with the screwdriver**

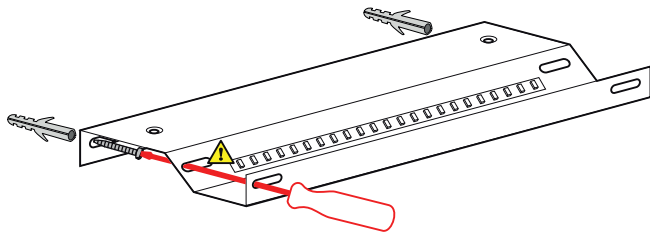

- 4) Effettuare il collegamento elettrico 
- 4) Make the electrical connection

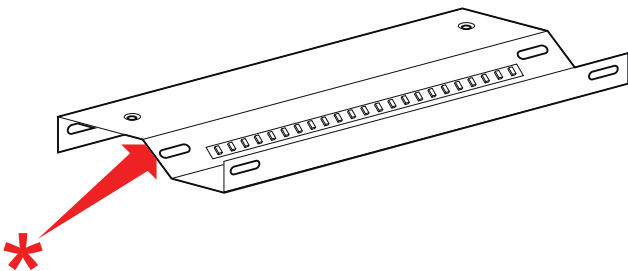

- 4) Chiudere l'apparecchio tramite le apposite viti 
- 4) Close the device using the screws

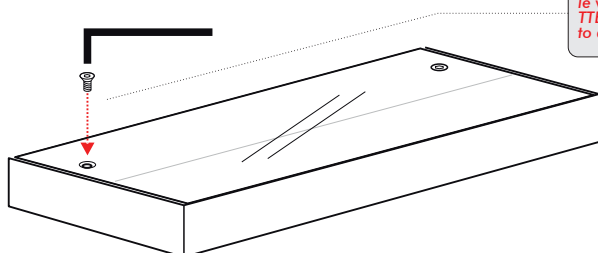

**ATTENZIONE: non stringere eccessivamente le viti per evitare la rottura del diffusore**  
**ATTENTION: do not over tighten the screws to avoid breaking the diffuser**

## PRODOTTO / PRODUCT

ARIELL

## MONTAGGIO / MOUNTING

Plafone / Ceiling

## CODICI / CODES

2026BOF - 2026BTF  
2026DOF - 2026DDM - 2026DTF  
2026FOF - 2026FDM  
2026MOF - 2026MDM  
20206NOF - 2026NDM

## n°INSTALLATORI / INSTALLERS n°



## STRUMENTI / INSTRUMENTS

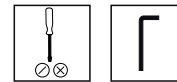

## TEMPO / TIME



## CERTIFICAZIONI / CERTIFICATIONS



## ATTENZIONE / CAUTION



Togliere la rete di alimentazione prima dell'installazione, sostituzione della lampada e comunque prima di ogni operazione di manutenzione.

**Always turn off power supply before install, replacing of the light bulb and prior to any maintenance interventions.**



La sicurezza dell'apparecchio è garantita solo con l'uso appropriato delle seguenti istruzioni; pertanto è necessario consultarle e conservarle.

**The safety of this product is guaranteed only if correctly used, according to this instruction sheet, which must be read first**

## COLLEGAMENTO ELETTRICO \* ELECTRICAL CONNECTION



Attenzione! Togliere la rete di alimentazione prima dell'installazione, sostituzione della lampada e comunque prima di ogni operazione di manutenzione.

**Caution!** Always turn off power supply before install, replacing of the light bulb and prior to any maintenance interventions.

### ON/OFF

Versione ONOFF  
ONOFF Version

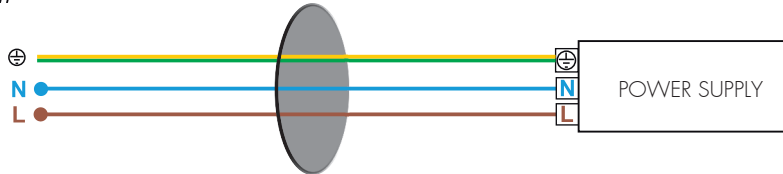

### DM

Versione dimmerabile - Collegamento con pulsante  
Dimmable Version - Touch-DIM wiring

Lampada 1  
Lamp 1

Lampada 2  
Lamp 2

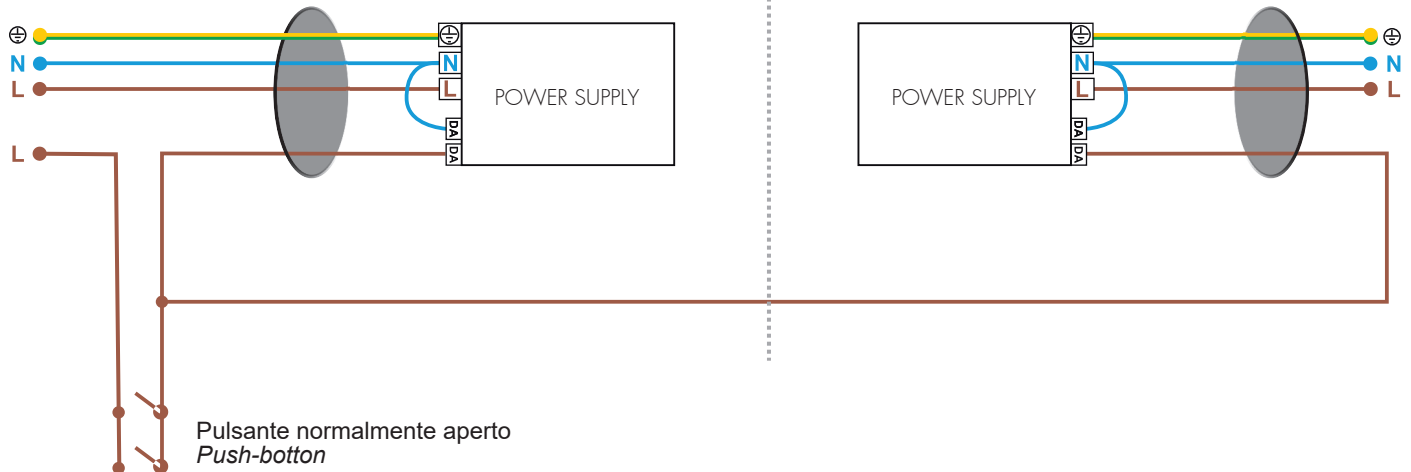

### DM

Versione dimmerabile - Collegamento con sistema di gestione  
Dimmable Version - Management System wiring

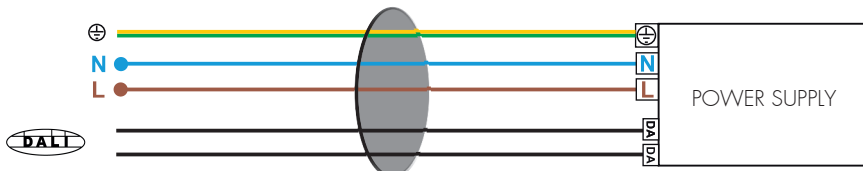

Sistema di gestione  
Management system

### TF

Versione TAGLIO DI FASE  
Phase CUT version

