

1) Fissare la lampada e il supporto con **tasselli adeguati al supporto.**  
1) Fix the lamp and the support **using the right dowels for the support.**

2) Effettuare il collegamento elettrico. \*  
2) Make the electrical connection.

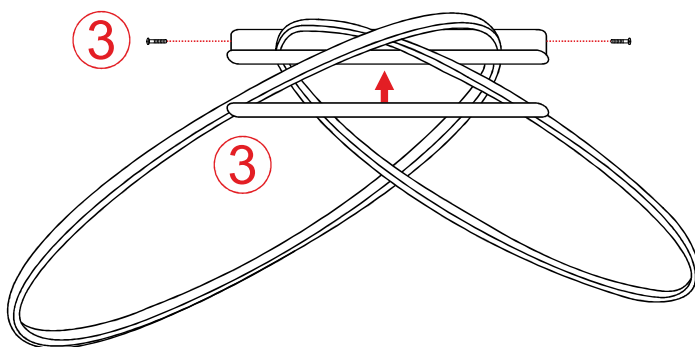

3) Chiudere il rosone con le viti fornite.  
3) Close the ceiling rose using the provided screws.

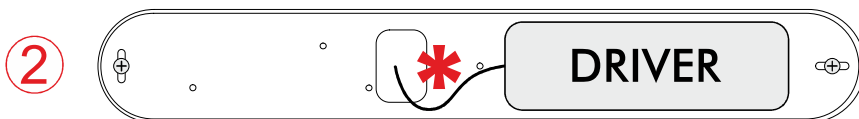
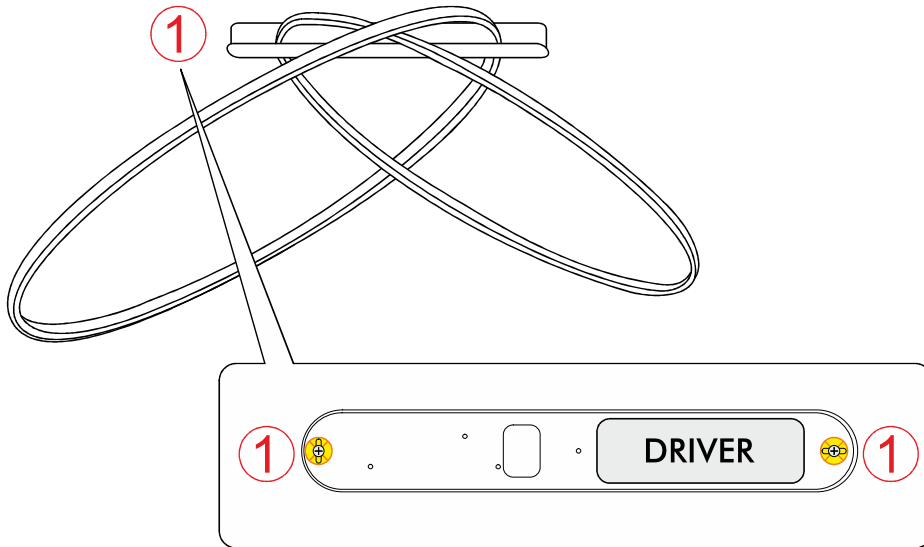

PRODOTTO / PRODUCT

Leggera

MONTAGGIO / MOUNTING

Plafone/Ceiling

CODICI / CODES

3032ABOF - 3032ABDM - 3032ABTF

n°INSTALLATORI / INSTALLERS n°



STRUMENTI / INSTRUMENTMENTS

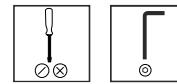

TEMPO / TIME



CERTIFICAZIONI / CERTIFICATIONS



ATTENZIONE / CAUTION



Togliere la rete di alimentazione prima dell'installazione, sostituzione della lampada e comunque prima di ogni operazione di manutenzione.

**Always turn off the power supply before installing, the replacement of the light bulb and to any maintenance intervention.**



La sicurezza dell'apparecchio è garantita solo con l'uso appropriato delle seguenti istruzioni; pertanto è necessario consultarle e conservarle.

**The safety of this product is guaranteed only if correctly used, according to this instruction sheet, which must be read first**

COLLEGAMENTO ELETTRICO  
ELECTRICAL CONNECTION



Versione ONOFF  
ONOFF Version

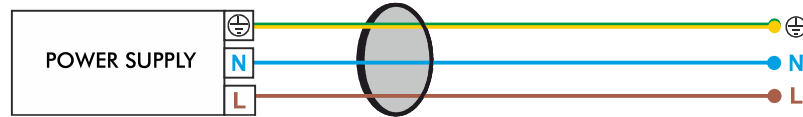

Versione Dimmerabile - Collegamento con pulsante  
Dimmable Version - Touch-DIM wiring

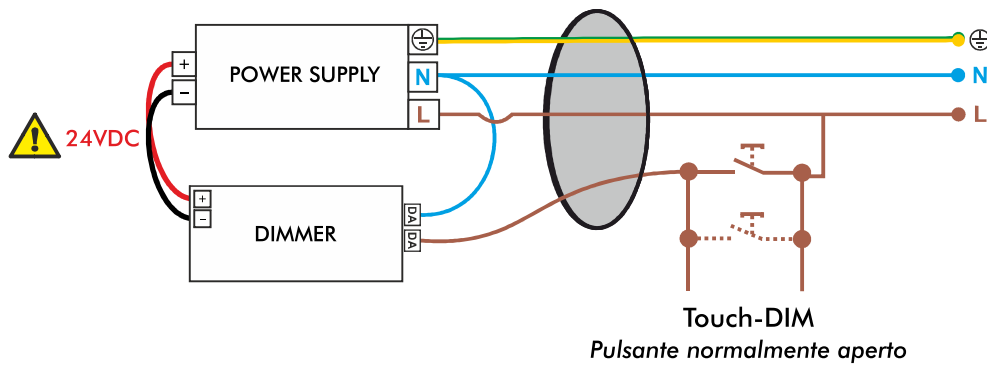

Versione Dimmerabile - Collegamento con sistema di gestione  
Dimmable Version - Management System wiring

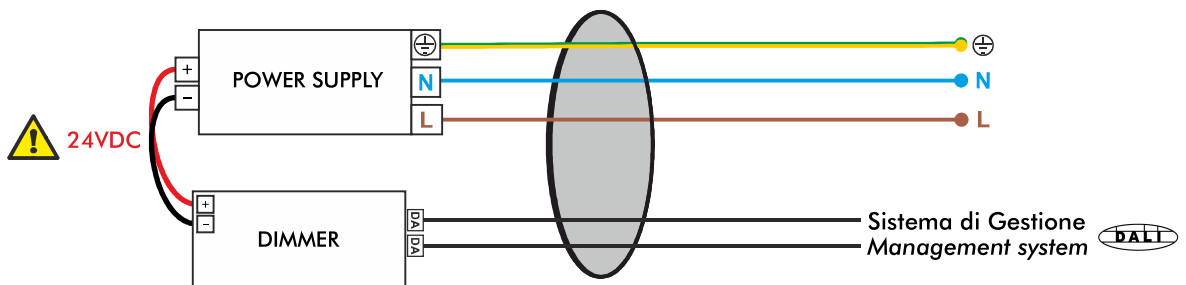

Versione Dimmerabile - Taglio di Fase  
Dimmable Version - Phase-Cut Dimmer

