



A) Fissare a plafone la staffa con tasselli adeguati al supporto.
A) Fix the stirrup using the right dowels for the support.

B) Effettuare il collegamento elettrico primario.  

C) Fissare il plafone alla staffa con le viti fornite.
C) Fix the ceiling using the provided screws.

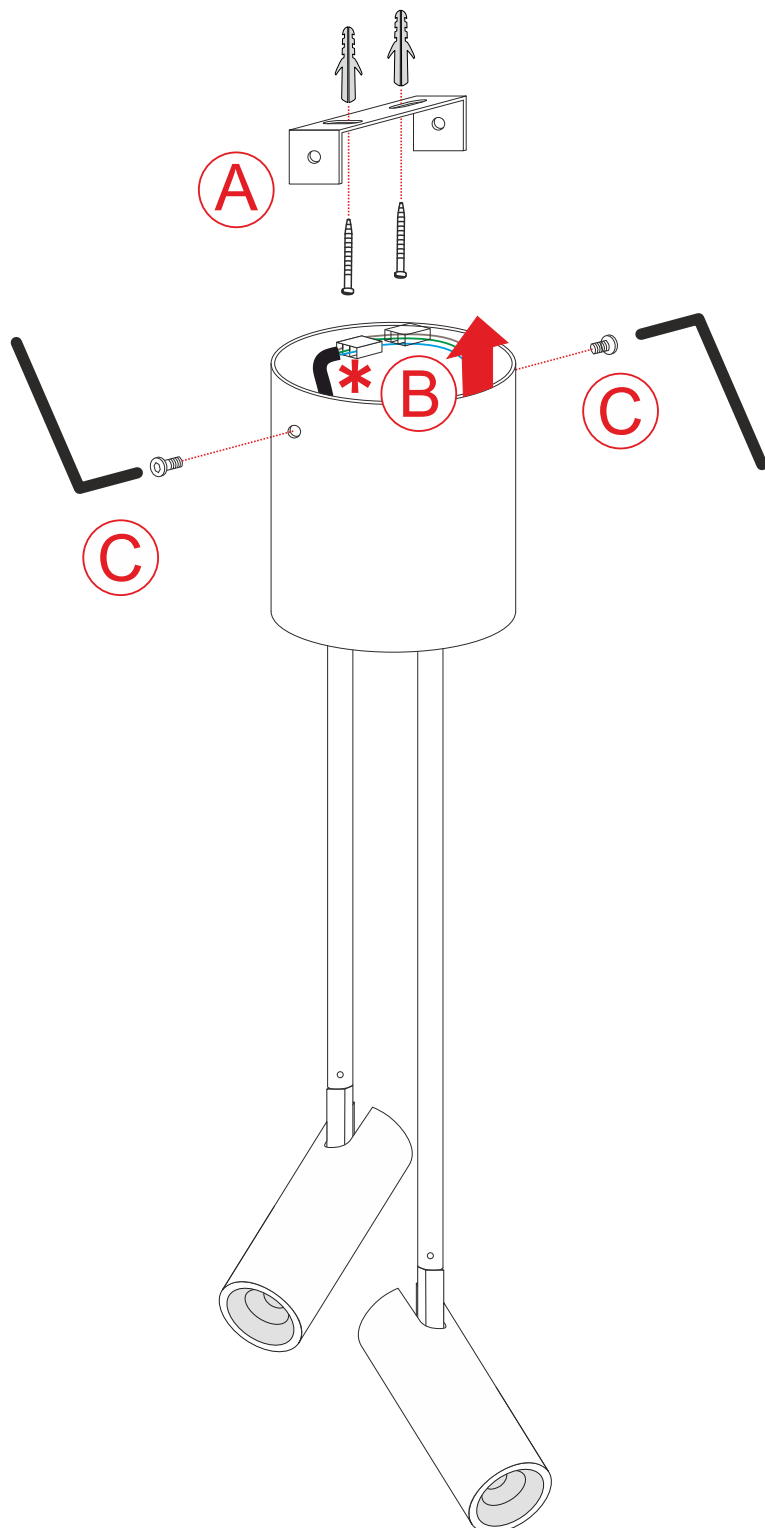

PRODOTTO / PRODUCT

MICRO

MONTAGGIO / MOUNTING

Plafone / Ceiling

CODICI / CODES

3039BOF - 3039BDM - 3039BTF

n°INSTALLATORI / n° INSTALLER



STRUMENTI / STRUMENTS

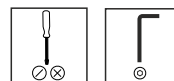

TEMPO / TIME



CERTIFICAZIONI / CERTIFICATIONS



ATTENZIONE / CAUTION



Togliere la rete di alimentazione prima dell'installazione, sostituzione della lampada e comunque prima di ogni operazione di manutenzione.

Always turn off power supply before install, replacing of the light bulb and prior to any maintenance interventions.



La sicurezza dell'apparecchio è garantita solo con l'uso appropriato delle seguenti istruzioni; pertanto è necessario consultarle e conservarle.

The safety of this product is guaranteed only if correctly used, according to this instruction sheet, which must be read first

COLLEGAMENTO ELETTRICO * ELECTRICAL CONNECTION



Attenzione! Togliere la rete di alimentazione prima dell'installazione, sostituzione della lampada e comunque prima di ogni operazione di manutenzione.

Caution! Always turn off power supply before install, replacing of the light bulb and prior to any maintenance interventions.

Versione ONOFF ONOFF Version

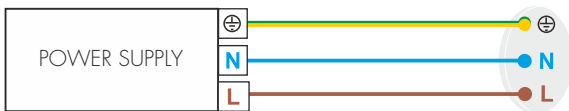

Versione dimmerabile - Collegamento con pulsante Dimmable Version - Touch-DIM wiring

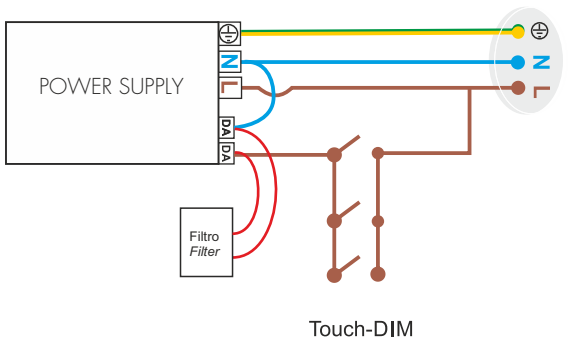

Versione dimmerabile - Collegamento con sistema di gestione Dimmable Version - Management System wiring

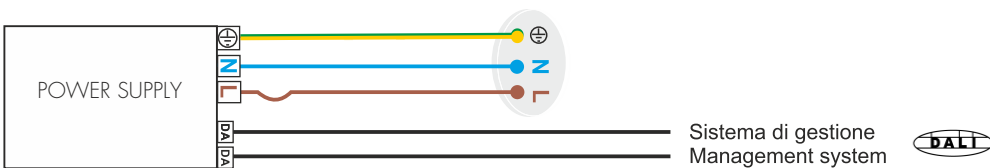

Versione TAGLIO DI FASE

