

A) Forare il cartongesso a seconda del prodotto scelto.
 A) Cut the plasterboard according to the chosen product.

B) Effettuare il collegamento elettrico primario. * 
 B) Make the primary electrical connection.

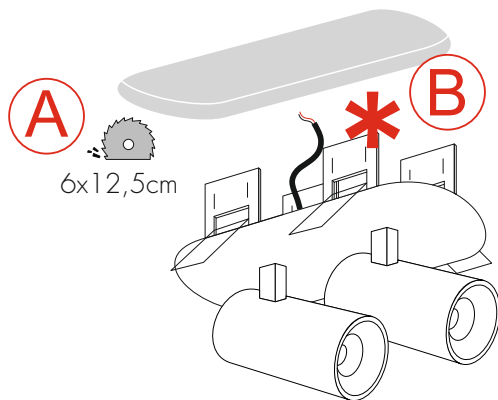

C) Inserire il prodotto nel cartongesso sollevando le molle.
 C) Insert the lamp into the plasterboard lifting the springs.

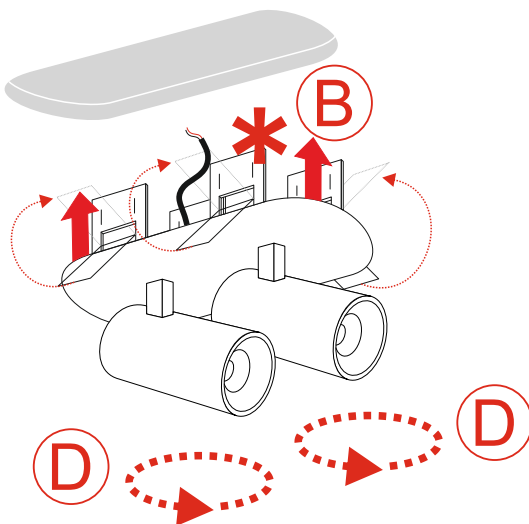

D) Ruotare i faretti a proprio piacimento.
 D) Turn the spotlights at will.

PRODOTTO / PRODUCT

TABLET ROUND

MONTAGGIO / MOUNTING

Semi-incasso / Semi-recessed

CODICI / CODES

4044Q

n°INSTALLATORI / INSTALLERS n°



STRUMENTI / INSTRUMENTS

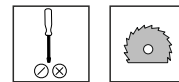

TEMPO / TIME



CERTIFICAZIONI / CERTIFICATIONS



ATTENZIONE / CAUTION



Togliere la rete di alimentazione prima dell'installazione, sostituzione della lampada e comunque prima di ogni operazione di manutenzione.

Always turn off power supply before install, replacing of the light bulb and prior to any maintenance interventions.



La sicurezza dell'apparecchio è garantita solo con l'uso appropriato delle seguenti istruzioni; pertanto è necessario consultarle e conservarle.

The safety of this product is guaranteed only if correctly used, according to this instruction sheet, which must be read first

COLLEGAMENTO ELETTRICO *
ELECTRICAL CONNECTION



Attenzione! Togliere la rete di alimentazione prima dell'installazione, sostituzione della lampada e comunque prima di ogni operazione di manutenzione.

Caution! Always turn off power supply before install, replacing of the light bulb and prior to any maintenance interventions.

Versione ONOFF
ONOFF Version

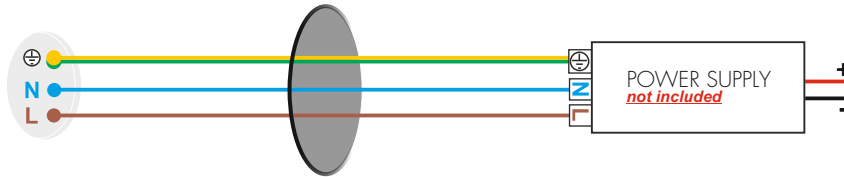

Versione dimmerabile - Collegamento con pulsante
Dimmable Version - Touch-DIM wiring

Lampada 1 Lampada 2

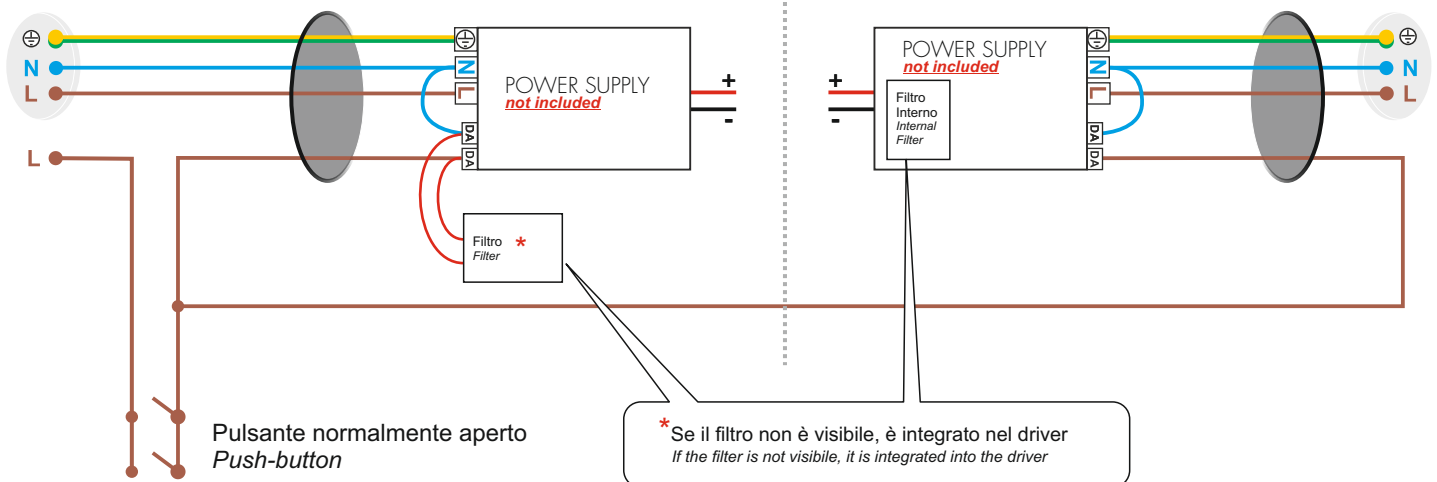

Versione dimmerabile - Collegamento con sistema di gestione
Dimmable Version - Management System wiring

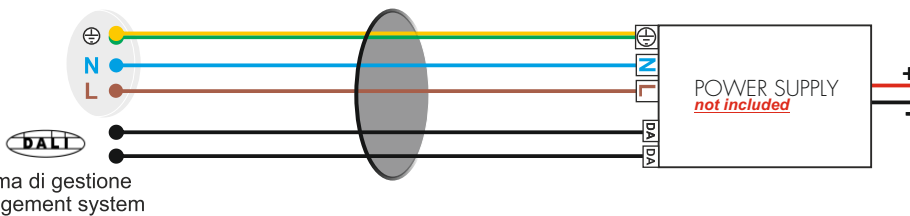

Sistema di gestione
Management system

Versione TAGLIO DI FASE
Phase CUT version

