

A) Fissare i millimetrici a plafone con tasselli adeguati al supporto e regolare il cavo.
A) Fix the griplocks using the right dowels for the support and adjust the cable.

B) Fissare la staffa a plafone ed effettuare il collegamento elettrico. * ⚠
B) Fix the stirrup to the ceiling and make the electrical connection.

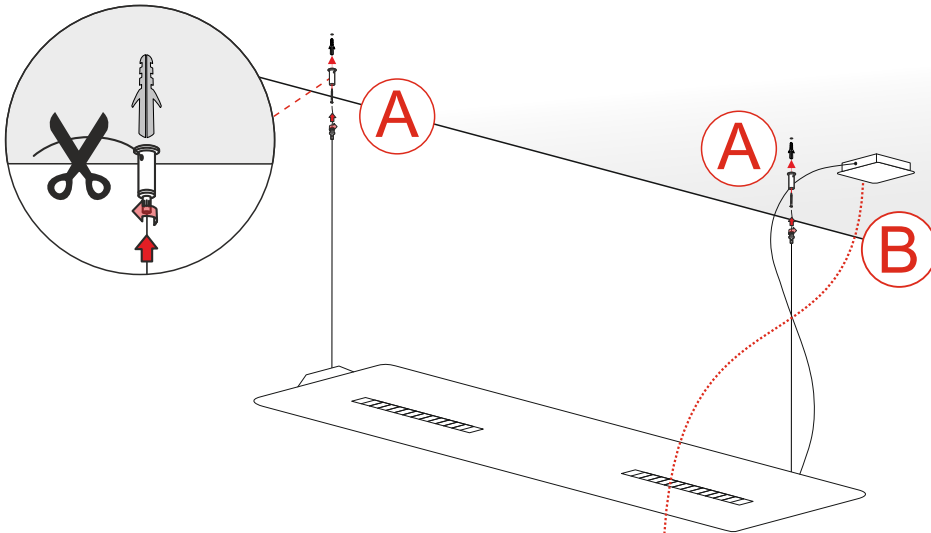

C) Chiudere il rosone con le viti fornite.
C) Close the rose with the supplied screws.

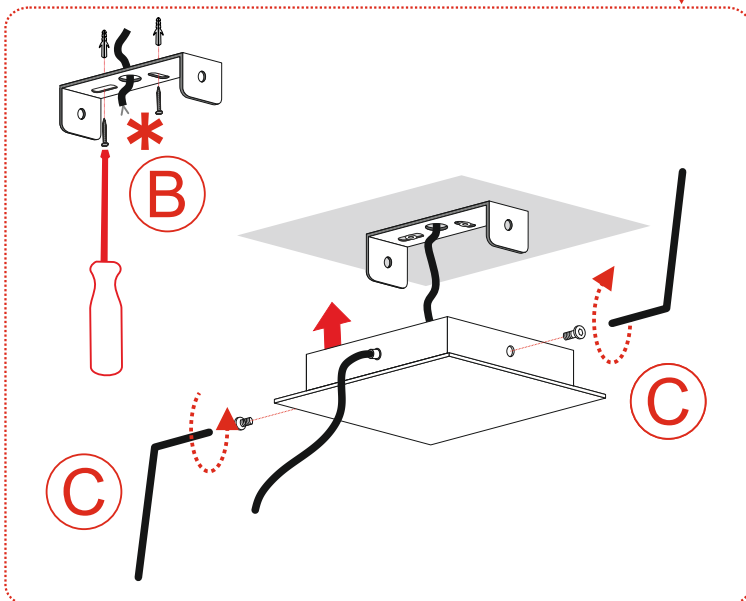

D) Regolare l'inclinazione del cavo sospensione, stringendo il grano sotto lo snodo.
D) Set the inclination suspension cable, tighten the dowel under the suspension articulation.

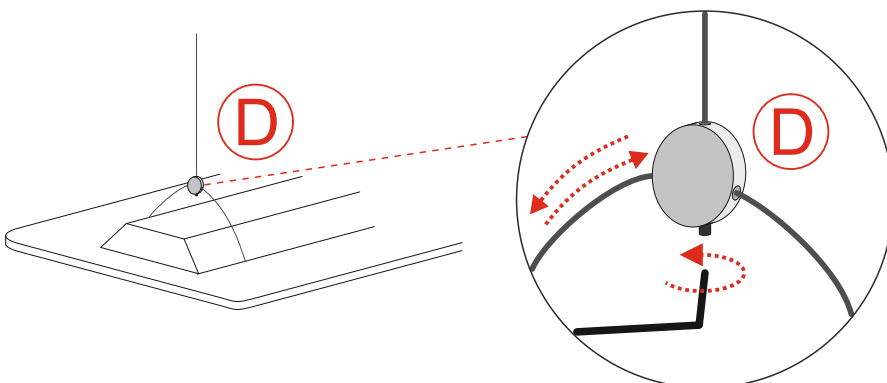

PRODOTTO / PRODUCT

RIFLESSA DARK

MONTAGGIO / MOUNTING

Sospensione

CODICI / CODES

1053EOF - 1053EDM - 1053EBT

n°INSTALLATORI / INSTALLERS n°



STRUMENTI / STRUMENTS

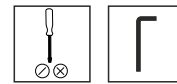

TEMPO / TIME



CERTIFICAZIONI / CERTIFICATIONS



ATTENZIONE / CAUTION



Togliere la rete di alimentazione prima dell'installazione, sostituzione della lampada e comunque prima di ogni operazione di manutenzione.

Always turn off power supply before install, replacing of the light bulb and prior to any maintenance interventions.



La sicurezza dell'apparecchio è garantita solo con l'uso appropriato delle seguenti istruzioni; pertanto è necessario consultarle e conservarle.

The safety of this product is guaranteed only if correctly used, according to this instruction sheet, which must be read first

COLLEGAMENTO ELETTRICO *
ELECTRICAL CONNECTION



Attenzione! Togliere la rete di alimentazione prima dell'installazione, sostituzione della lampada e comunque prima di ogni operazione di manutenzione.

Caution! Always turn off power supply before install, replacing of the light bulb and prior to any maintenance interventions.

Versione ONOFF
ONOFF Version

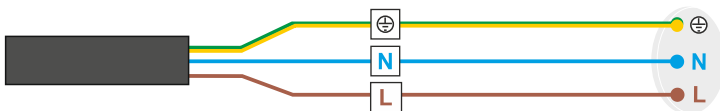

Versione dimmerabile - Collegamento con pulsante
Dimmable Version - Touch-DIM wiring

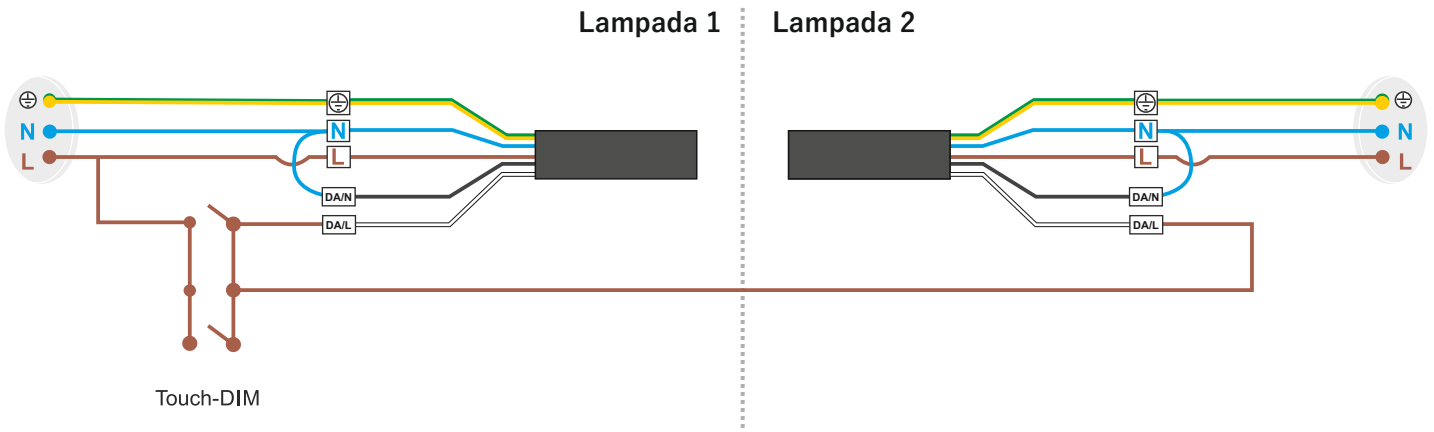

 Versione dimmerabile - Collegamento con sistema di gestione
Dimmable Version - Management System wiring

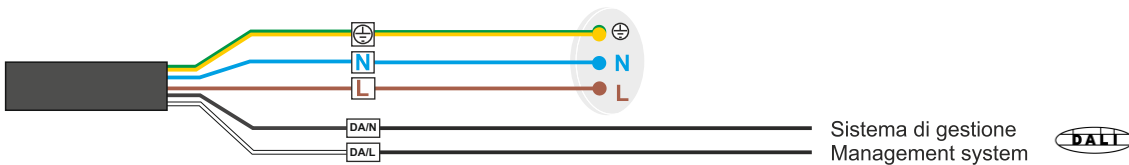

 Versione BLUETOOTH
BLUETOOTH version

