

ISTRUZIONI DI MONTAGGIO

ASSEMBLY INSTRUCTIONS

- 1) Rimuovere il diffusore
- 1) Remove the diffuser

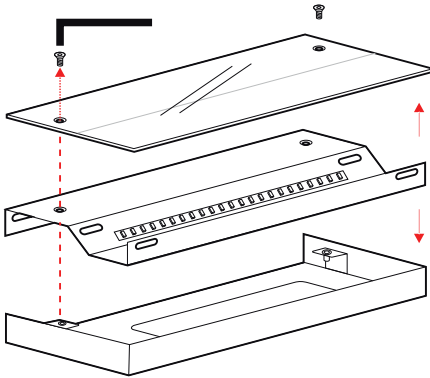

- 2) Fissare la base alla parete con tasselli adeguati al supporto **prestare attenzione a non danneggiare il LED con il cacciavite**
- 2) Attach the base to the wall with adequate **support anchors** **be careful not to damage the LED with the screwdriver**

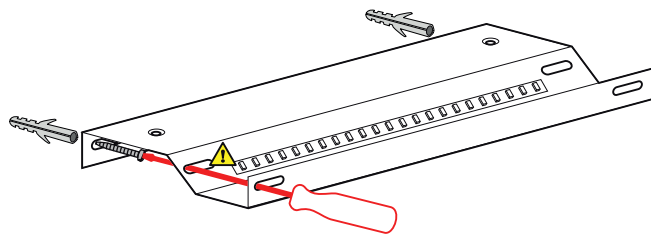

- 4) Effettuare il collegamento elettrico 
- 4) Make the electrical connection

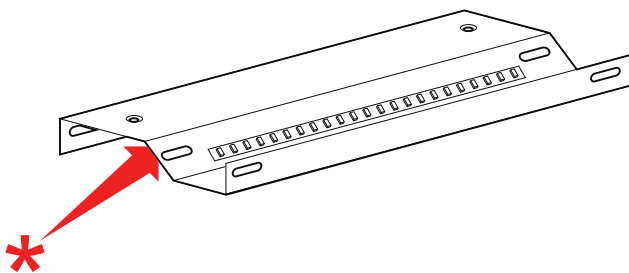

- 4) Chiudere l'apparecchio tramite le apposite viti 
- 4) Close the device using the screws

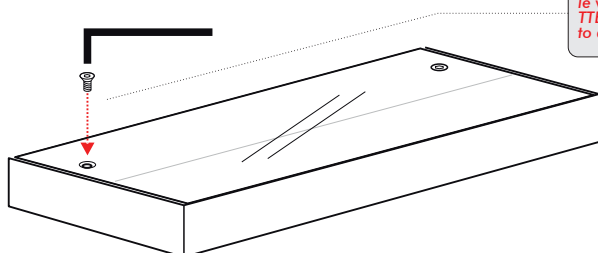

ATTENZIONE: non stringere eccessivamente le viti per evitare la rottura del diffusore
ATTENTION: do not over tighten the screws to avoid breaking the diffuser

PRODOTTO / PRODUCT

ARIELL

MONTAGGIO / MOUNTING

Plafone / Ceiling

CODICI / CODES

2026OOF - 2026ODM

n°INSTALLATORI / INSTALLERS n°



STRUMENTI / INSTRUMENTS

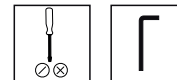

TEMPO / TIME



CERTIFICAZIONI / CERTIFICATIONS



ATTENZIONE / CAUTION



Togliere la rete di alimentazione prima dell'installazione, sostituzione della lampada e comunque prima di ogni operazione di manutenzione.

Always turn off power supply before install, replacing of the light bulb and prior to any maintenance interventions.



La sicurezza dell'apparecchio è garantita solo con l'uso appropriato delle seguenti istruzioni; pertanto è necessario consultarle e conservarle.

The safety of this product is guaranteed only if correctly used, according to this instruction sheet, which must be read first

COLLEGAMENTO ELETTRICO *
ELECTRICAL CONNECTION



Attenzione! Togliere la rete di alimentazione prima dell'installazione, sostituzione della lampada e comunque prima di ogni operazione di manutenzione.

Caution! Always turn off power supply before install, replacing of the light bulb and prior to any maintenance interventions.

ON/OFF

Versione ONOFF
ONOFF Version

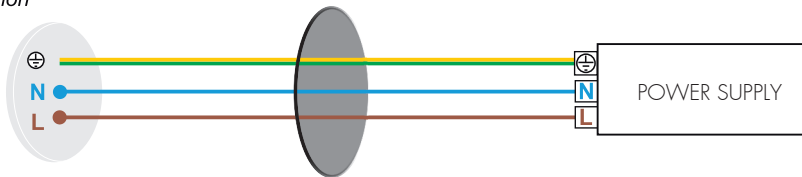

DM

Versione dimmerabile - Collegamento con pulsante
Dimmable Version - Touch-DIM wiring

Lampada 1 Lampada 2

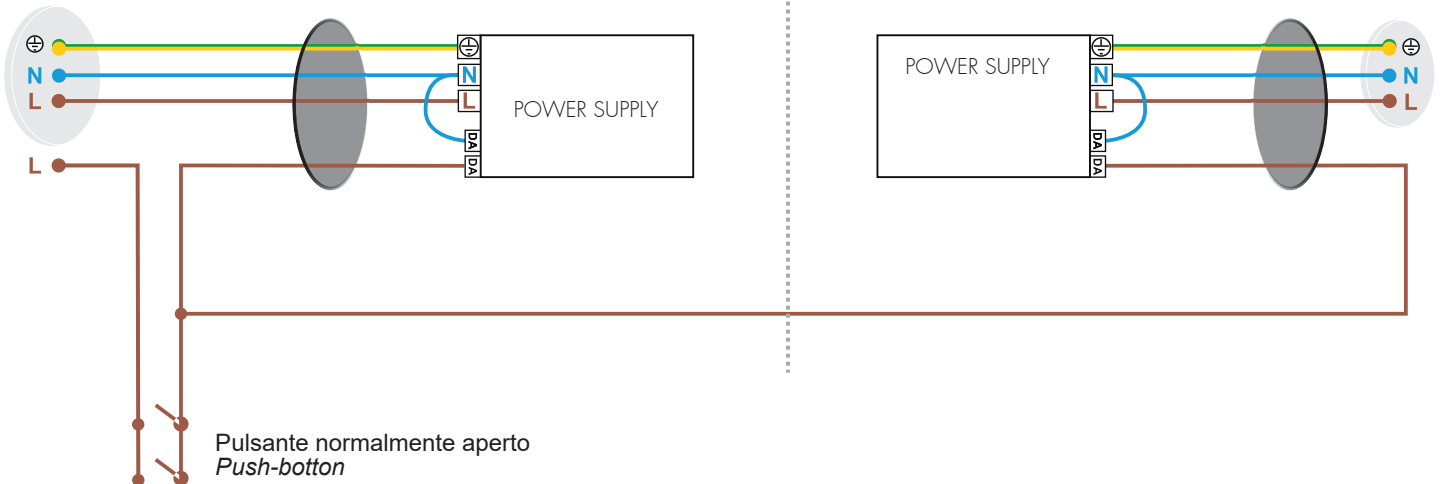

DM

Versione dimmerabile - Collegamento con sistema di gestione
Dimmable Version - Management System wiring

