

## COMPOSIZIONE PRODOTTO PRODUCT COMPOSITION PRODUKTZUSAMMENSETZUNG

### PRODOTTO / PRODUCT / PRODUKT

Emme24 downlight 345x345

### MONTAGGIO / MOUNTING / MONTAGE

Sospensione

### CODICE / CODE

# 1037T

### N° COLLI / N° PARCELS / N° PACK

# 9

### PESO / WEIGHT / GEWICHT

# 22KG

## CONTENUTO COLLI - PARCELS CONTENTS - PACKUNGSINHALT

4pz

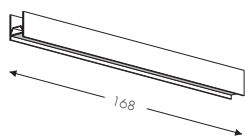

**1037D - Emme24 Giunto - Giunto L168cm**

Emme24 Linear Joint L168cm  
Emme24 Lineargelenk L168cm

4pz

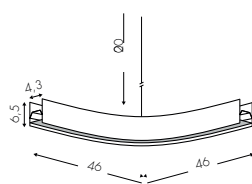

**1037KGR - Emme24 Arco R46**

Emme24 R46 Arc  
Emme24 Bogen

6pz



**90101037GM - Giunto Meccanico**  
Mechanical Coupling - Mechanisches Gelenk

6pz

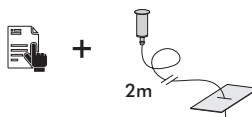

**90101037K - Kit Sospensione**  
Suspension Kit - Fahrwerkssatz

5pz

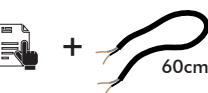

**90100037GEOF - Cavo 2 Poli 24V L.60cm**  
2 Poles Cable 24V L.60cm  
Elektrische Kabel 2 Poles 24V L.60cm

1pz

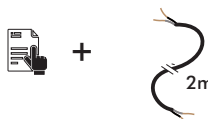

**90101037GAOF - Cavo alimentazione 2 Poli 24V L.200cm**  
2-Poles power cable L.200cm  
Netzkabel 2 Poles 24V L.200cm

1pz

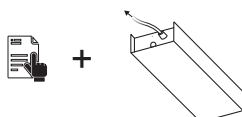

**9037COF Alimentatore/Driver On Off 240W - 220V**  
**9037CDM Alimentatore/Driver DALI (Push) 240W - 220V**

**1037T 1/9**

**1037T 2/9**

**1037T 3/9**

**1037T 4/9**

**1037T 5/7**

**1037T 6/7**

**1037T 7/7**

**1037T 8/7**

**1037T 9/7**

**(ACCESSORI +  
ALIMENTATORE)**

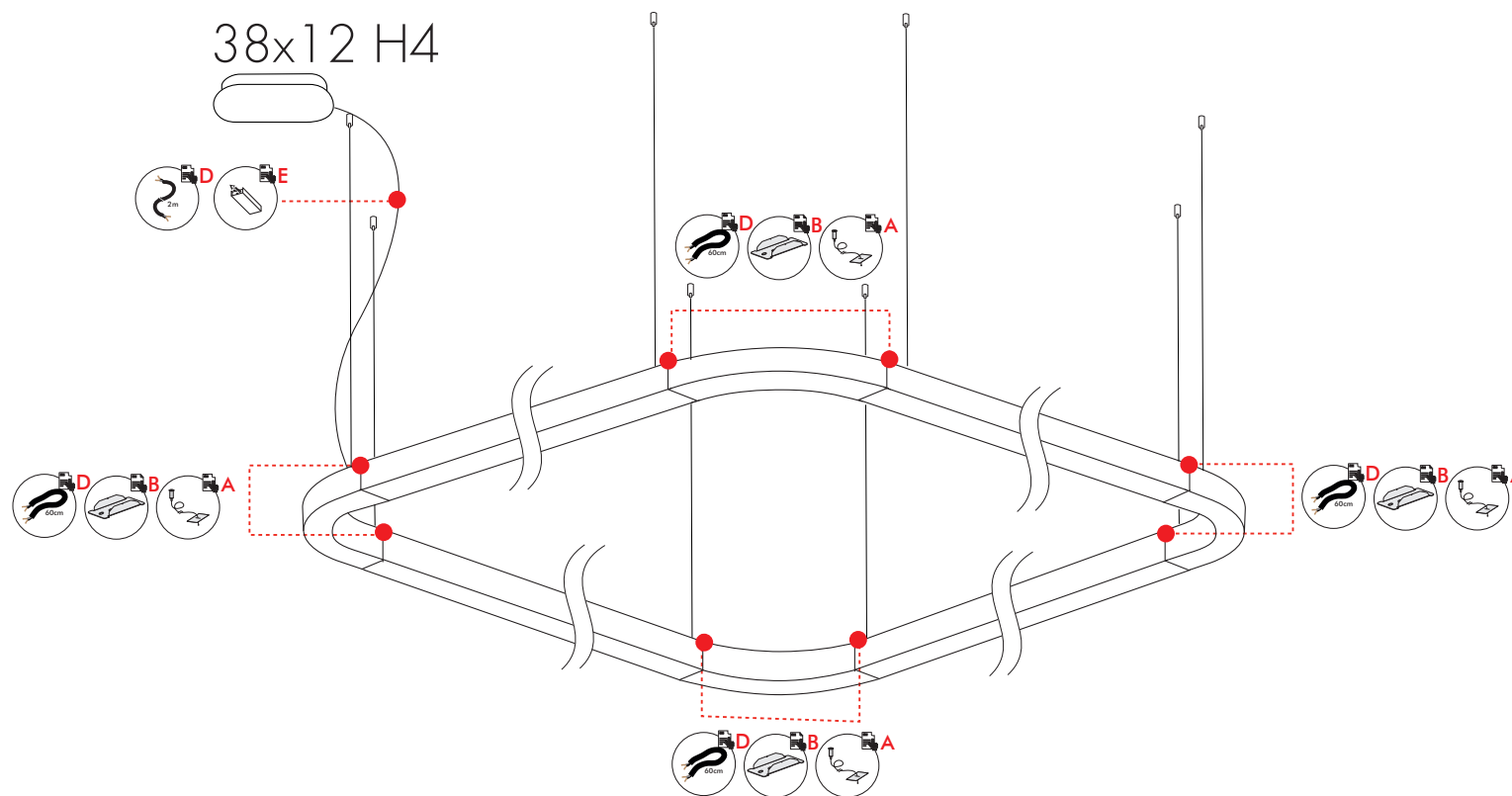

PRODOTTO / PRODUCT / PRODUKT

Emme24 downlight 92x345

MONTAGGIO / MOUNTING / MONTAGE

Sospensione

CODICE / CODE

**1037S**

ATTENZIONE / WARNING / ACHTUNG



Togliere la rete di alimentazione prima dell'installazione, sostituzione della lampada e comunque prima di ogni operazione di manutenzione.

*Always turn off power supply before install, replacing of the light bulb and prior to any maintenance interventions.*

*Trennen Sie das Versorgungsnetz vor der Installation, vor dem Auswechseln der Glühlampe und auf jeden Fall vor Wartungsarbeiten.*

## SEQUENZA DI MONTAGGIO - ASSEMBLY SEQUENCE - MONTAGEREIHENFOLGE

### 1. ASSEMBLAGGIO STRUTTURA:

- A Kit Sospensione cod. 90101037K
- B Giunto Meccanico cod. 90101037GM

### 2. COLLEGAMENTO ELETTRICO:

- C Cavo alimentazione 2 Poli 24V L.200cm cod.90101037GAOF
- D Cavo 2 Poli 24V L.60cm cod.90100037GEOF
- E 9037COF/CDM Alimentatore On Off/DALI (Push) 240W - 220V

### 1. STRUCTURE ASSEMBLY:

- A Suspension Kit cod. 90101037K
- B Mechanical Coupling cod. 90101037GM

### 2. ELECTRICAL CONNECTION:

- C 2 Poles power cable L.200cm cod. 90100037GAOF
- D 2 Poles cable 24V L.60cm cod.90100037GEOF
- E 9037COF/CDM Driver On Off/DALI (Push) 240W - 220V

### 1. STRUKTUR-MONTAGE:

- A Fahrwerkssatz cod. 90101037K
- B Mechanisches Gelenk cod. 90101037GM

### 2. ELEKTRISCHE VERBINDUNG:

- C Netzkabel 2 poles L.200cm cod.90101037GAOF
- D Elektrische Kabel 2 poles 24V L.60cm cod.90100037GEOF
- E 9037COF/CDM Driver On Off/DALI (Push) 240W - 220V



Per la corretta installazione del prodotto, consultare preventivamente le **istruzioni specifiche** di ogni accessorio.

For the proper installation of the product, consult the **specific instructions** of each accessory.

Für eine korrekte Installation des Produkts, müssen Sie die **spezifischen Anweisungen** für jedes Zubehör zu konsultieren.

[www.teamitaliailluminazione.it](http://www.teamitaliailluminazione.it) info@teamitaliailluminazione.it

Via dell'Artigianato 21, 37066 Caselle di Sommacampagna, Verona (Italy) tel +39.045.85.81.640 fax +39.045.85.81.650



La sicurezza dell'apparecchio è garantita solo con l'uso appropriato delle seguenti istruzioni; pertanto è necessario consultarle e conservarle.

*The safety of this product is guaranteed only if correctly used, according to this instruction sheet, which must be read first*

*Die Sicherheit des Geräts ist nur bei bestimmungsgemäßer Verwendung der folgenden Anweisungen gewährleistet. Daher ist es notwendig, sie zu konsultieren und aufzubewahren.*