

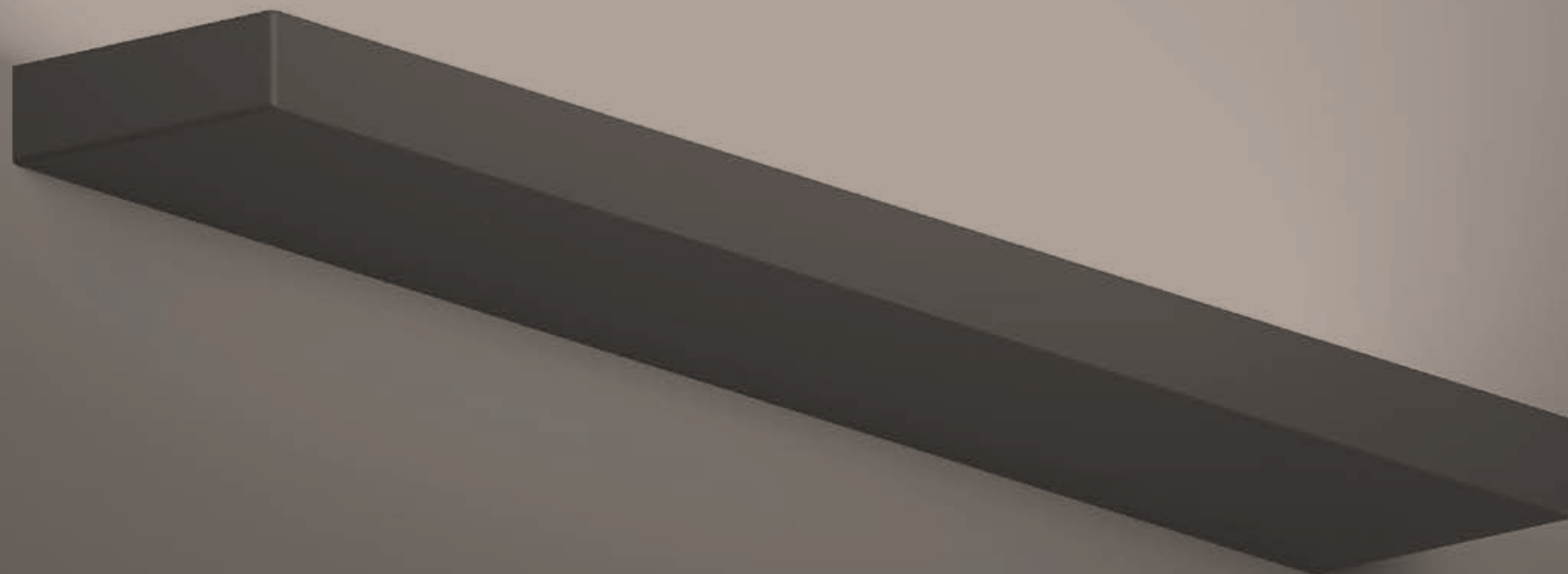

NOVITÀ • NEW PRODUCTS • NEUER PRODUKTE



EUROLUCE 2023



PARETE
WALL LIGHT
WANDLEUCHTE





configurazione standard: / basic configuration: / Standard Konfiguration:

E28 Satinato
Frosted - Satiniert

B 3000K

BV

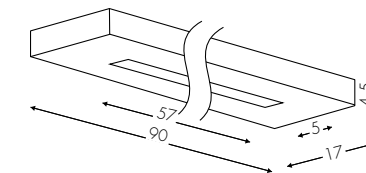

2026QOFBVE28B
2026QDMBVE28B

50W 6500lm + 10W 1500lm - 220V

DALI (Push) - 50W 6500lm + 10W 1500lm - 220V

557,00 €

611,00 €

Configura 

Configure / Konfigurieren

www.teamitaliailluminazione.it 



A 2700K

NE RU



A Alimentatore Incorporato - Incorporated Power Supply - Eingebautes Netzteil

* 6500lm effettivi - effective - effektive con - with - mit **E28**

CODICE COMPLETO DEL PRODOTTO NELLA FOTO
FULL PRODUCT CODE AS SHOWN IN PICTURE - VOLLSTÄNDIGER CODE VOM ARTIKEL IM BILD

2026QOF **NE** **E28** **A**

Codice
Code

Finitura
Finishing
Lackierung

Diffusore
Diffuser
Diffusor

Tonalità
Hue
Farbton

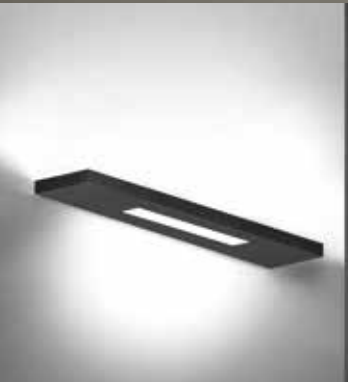

OVERLAP DECÓ

PARETE
WALL LIGHT
WANDLEUCHTE



configurazione standard: / basic configuration: / Standard Konfiguration:

E2 Opale - Opal

B 3000K

BV

2015ATFBVE2B

26W 2295lm* + 13W 1150lm - 220V

460,00 €

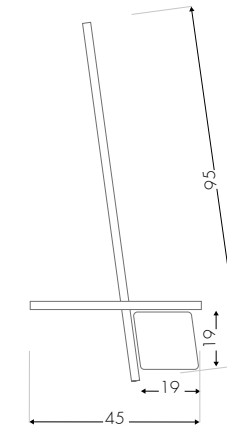
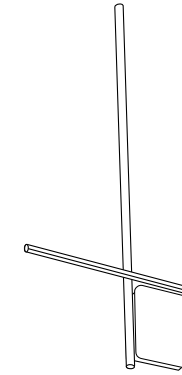

Configura

Configure / Konfigurieren

www.teamitaliailluminazione.it



A 2700K

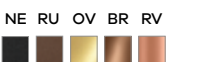

CODICE COMPLETO DEL PRODOTTO NELLA FOTO
FULL PRODUCT CODE AS SHOWN IN PICTURE - VOLLSTÄNDIGER CODE VOM ARTIKEL IM BILD

2015ATF **OV** **E2** **B**

Codice
Code

Finitura
Finishing
Lackierung

Diffusore
Diffuser
Diffusor

Tonalità
Hue
Farbton

TF Taglio di Fase - Phase-Cut Dimmer - Phasenabschnittdimmer

A Alimentatore Incorporato - Incorporated Power Supply - Eingebautes Netzteil

* 2295lm effettivi - effective - effektive con - with - mit **E2**

LEGGERA

PARETE
WALL LIGHT
WANDLEUCHTE



configurazione standard: / basic configuration: / Standard Konfiguration:

E2 Opale - Opal

● B 3000K

BV

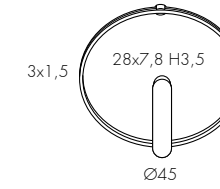

2032COFBVE2B
2032CDMBVE2B
2032CTFBVE2B

25W 1260lm* - 220V
DALI (Push) - 25W 1260lm - 220V
25W 1260lm - 220V

474,00 €
553,00 €
553,00 €

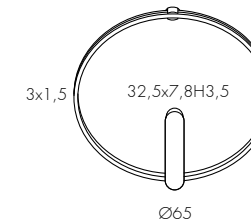

2032AOFBVE2B
2032ADMBVE2B
2032ATFBVE2B

35W 1740lm - 220V
DALI (Push) - 35W 1740lm - 220V
35W 1740lm - 220V

601,00 €
697,00 €
697,00 €

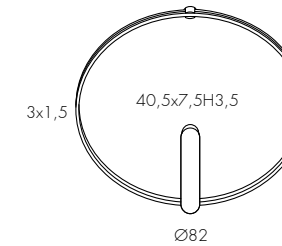

2032BOFBVE2B
2032BDMBVE2B
2032BTFBVE2B

48W 2580lm - 220V
DALI (Push) - 48W 2580lm - 220V
48W 2580lm - 220V

709,00 €
808,00 €
808,00 €

Configura

Configure / Konfigurieren

www.teamitaliailluminazione.it



● A 2700K

NE RV BR OV

CODICE COMPLETO DEL PRODOTTO NELLA FOTO
FULL PRODUCT CODE AS SHOWN IN PICTURE - VOLLSTÄNDIGER CODE VOM ARTIKEL IM BILD

2032BOF **OV** **E2** **A**

Codice Code	Finitura Finishing Lackierung	Diffusore Diffuser Diffusor	Tonalità Hue Farbton
----------------	-------------------------------------	-----------------------------------	----------------------------

TF Taglio di Fase - Phase-Cut Dimmer - Phasenabschnittdimmer

A Alimentatore Incorporato - Incorporated Power Supply - Eingebautes Netzteil

* 1260lm effettivi - effective - effektive con - with - mit **E2**

configurazione standard: / basic configuration: / Standard Konfiguration:

E28 Satinato
Frosted - Satinert

B 3000K

BV



2018BTFBVE28B

18W 1700lm* - 220V

165,00 €

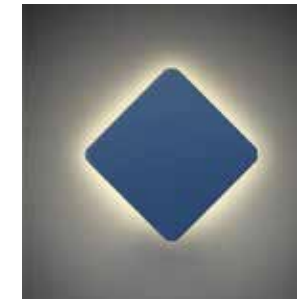
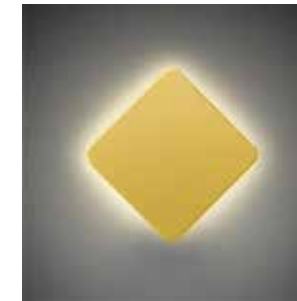
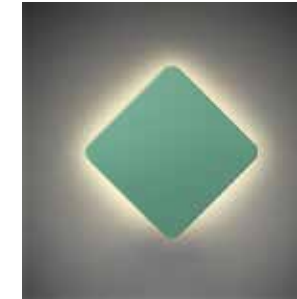

Configura

Configure / Konfigurieren

www.teamitaliailluminazione.it



CODICE COMPLETO DEL PRODOTTO NELLA FOTO
FULL PRODUCT CODE AS SHOWN IN PICTURE - VOLLSTÄNDIGER CODE VOM ARTIKEL IM BILD

2018BTF | **BV** | **E28** | **B**

Codice
Code

Finitura
Finishing
Lackierung

Diffusore
Diffuser
Diffusor

Tonalità
Hue
Farbton

TF Taglio di Fase - Phase-Cut Dimmer - Phasenabschnittdimmer

A Alimentatore Incorporato - Incorporated Power Supply - Eingebautes Netzteil

* 1700lm effettivi - effective - effektive con - with - mit **E28**



configurazione standard: / basic configuration: / Standard Konfiguration:

E28 Satinato
Frosted - Satinert

B 3000K

BV

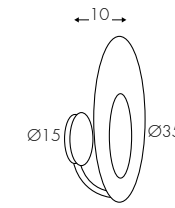

2038AOFBVE28B

15W 1900lm* - 220V

407,00 €

2038ADMBVE28B

DALI (Push) - 15W 1900lm - 220V

478,00 €

2038ATFBVE28B

15W 1900lm - 220V

478,00 €

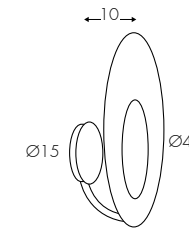

2038BOFBVE28B

18W 2600lm - 220V

464,00 €

2038BDMBVE28B

DALI (Push) - 18W 2600lm - 220V

531,00 €

2038BTFBVE28B

18W 2600lm - 220V

531,00 €

Configura 

Configure / Konfigurieren

www.teamitaliailluminazione.it 



A 2700K

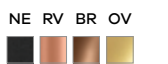

CODICE COMPLETO DEL PRODOTTO NELLA FOTO
FULL PRODUCT CODE AS SHOWN IN PICTURE - VOLLSTÄNDIGER CODE VOM ARTIKEL IM BILD

2038AOF **BV** **E28** **B**

Codice
Code

Finitura
Finishing
Lackierung

Diffusore
Diffuser
Diffusor

Tonalità
Hue
Farbton

TF Taglio di Fase - Phase-Cut Dimmer - Phasenabschnittdimmer

A Alimentatore Incorporato - Incorporated Power Supply - Eingebautes Netzteil

* 1900lm effettivi - effective - effektive con - with - mit **E28**



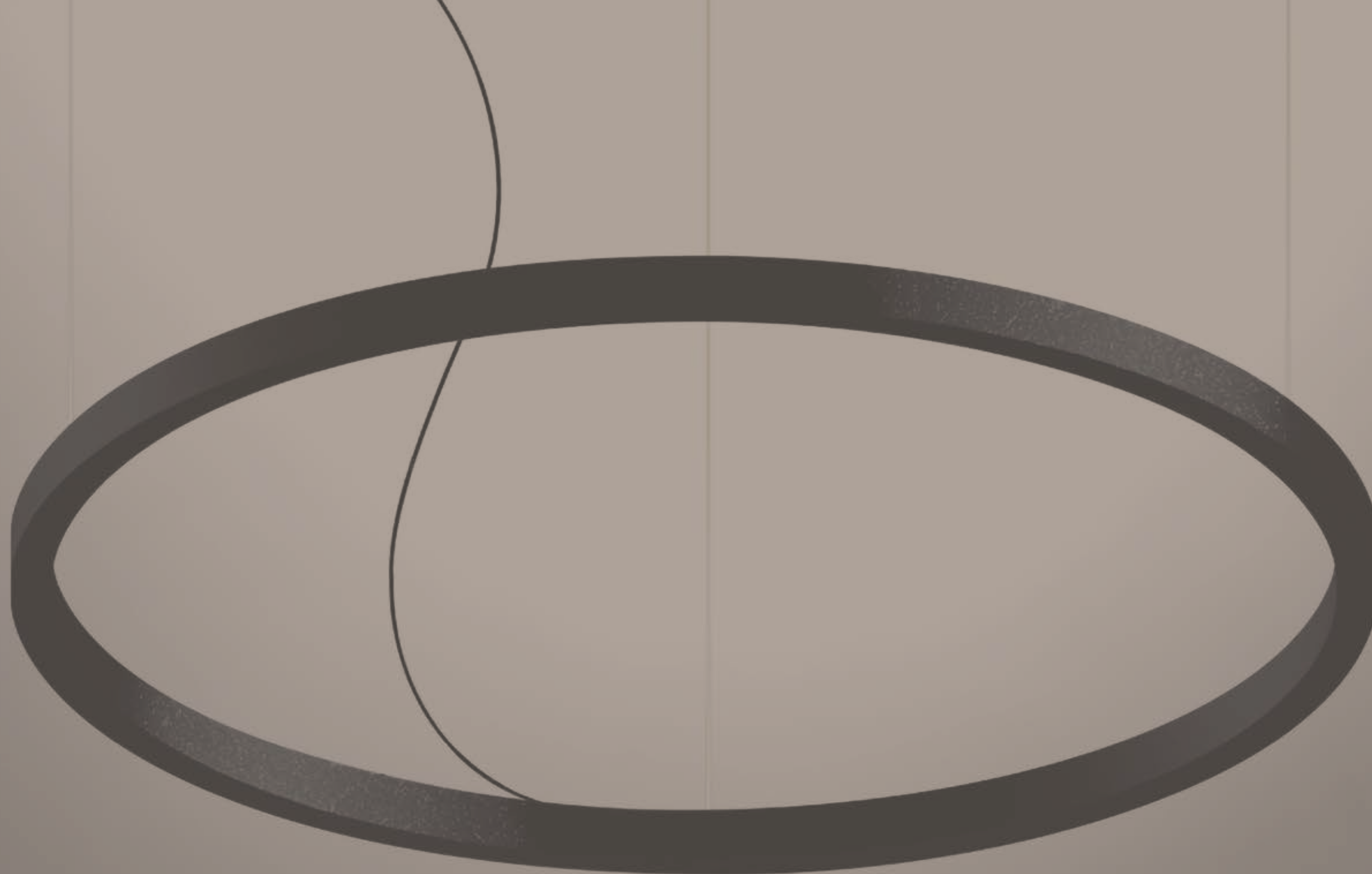

SOSPENSIONE
SUSPENSION LAMP
PEDELLEUCHTE





CHAPEAU

SOSPENSIONE
SUSPENSION LAMP
PENDELLEUCHE



configurazione standard: / basic configuration: / Standard Konfiguration:

E2 Opale - Opal

B 3000K

BV



1087BTFBVE2B

18W 1620lm* - 220V

430,00 €

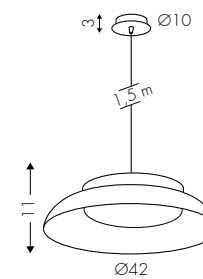

1087DTFBVE2B

30W 3000lm - 220V

560,00 €

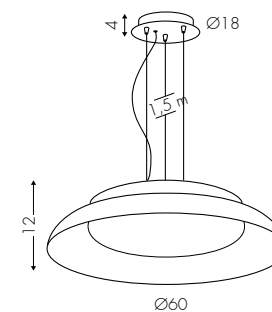

Configura

Configure / Konfigurieren

www.teamitaliailluminazione.it



CODICE COMPLETO DEL PRODOTTO NELLA FOTO
FULL PRODUCT CODE AS SHOWN IN PICTURE - VOLLSTÄNDIGER CODE VOM ARTIKEL IM BILD

1087BTF **RV** **E2** **B**

Codice
Code

Finitura
Finishing
Lackierung

Diffusore
Diffuser
Diffusor

Tonalità
Hue
Farbton

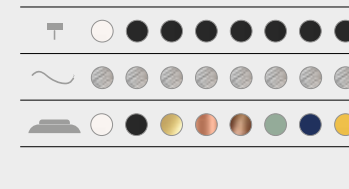
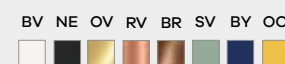

TF Taglio di Fase - Phase-Cut Dimmer - Phasenabschnittdimmer

A Alimentatore Incorporato - Incorporated Power Supply - Eingebautes Netzteil

* 1620lm effettivi - effective - effektiven con - with - mit **E2**



EMME 24

SOSPENSIONE (composizione)
SUSPENSION (composition)
SUSPENSION (composition)



configurazione standard: / basic configuration: / Standard Konfiguration:

E2 Opale - Opal

B 3000K

BV

1037SOFBVE2B

184W 13540lm* - 220V

2.145,00 €

1037SDMBVE2B

DALI (Push) - 184W 13540lm - 220V

2.232,00 €

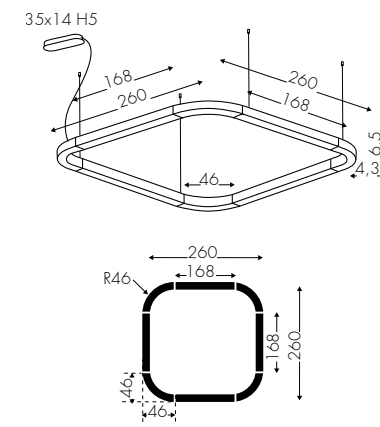
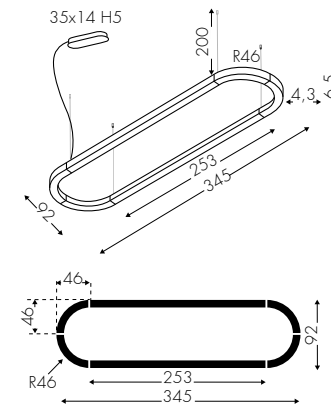

1037TOFBVE2B

220W 16355lm - 220V

2.565,00 €

1037TDMBVE2B

DALI (Push) - 220W 16355lm - 220V

2.652,00 €

Configura

Configure / Konfigurieren

www.teamitaliailluminazione.it



A

E19 UGR<19 Prism

C 4000K

NE

A Alimentatore nel rosone - Power Supply inside the ceiling rose - Netzteil in der Deckendose

* 13540lm effettivi - effective - effektive con - with - mit E2
15920lm effettivi - effective - effektive con - with - mit E19 +17,5%

CODICE COMPLETO DEL PRODOTTO NELLA FOTO
FULL PRODUCT CODE AS SHOWN IN PICTURE - VOLLSTÄNDIGER CODE VOM ARTIKEL IM BILD

1037SOF **NE** **E19** **B**

Codice Code	Finitura Finishing Lackierung	Diffusore Diffuser Diffusor	Tonalità Hue Farbton
----------------	-------------------------------------	-----------------------------------	----------------------------

BV

NE

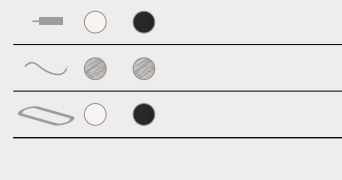

MELLOW

SOSPENSIONE (composizione)
SUSPENSION (composition)
SUSPENSION (composition)



configurazione standard: / basic configuration: / Standard Konfiguration:

E2 Opale - Opal - Opal ● B 3000K



1083ATFBVE2B 6,5W 900lm* - 220V

370,00 €

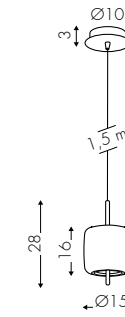

1083GTFBVE2B 3x6,5W 3x900lm - 220V

835,00 €

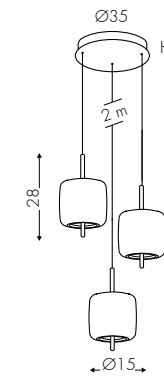

1083HTFBVE2B 6x6,5W 6x900lm - 220V

2.050,00 €

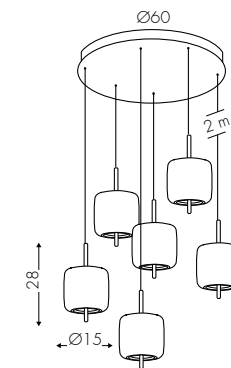

CO05T2NE Custom black cable

8,00 € /MT

Configura Configure / Konfigurieren

www.teamitaliailluminazione.it



● A 2700K

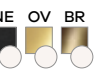

CODICE COMPLETO DEL PRODOTTO NELLA FOTO
FULL PRODUCT CODE AS SHOWN IN PICTURE - VOLLSTÄNDIGER CODE VOM ARTIKEL IM BILD

1083GTF **OV** **E2** **B**

Codice Code	Finitura Finishing Lackierung	Diffusore Diffuser Diffusor	Tonalità Hue Farbton
----------------	-------------------------------------	-----------------------------------	----------------------------

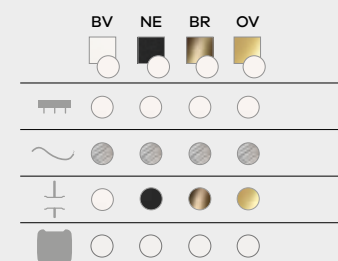

TF Taglio di Fase - Phase-Cut Dimmer - Phasenabschnittdimmer

A Alimentatore nel rosone - Power Supply inside the ceiling rose - Netzteil in der Deckendose

* 900lm effettivi - effective - effektive con - with - mit **E2**



BF custom finish

configurazione standard: / basic configuration: / Standard Konfiguration:

E2 Opale - Opal - Opal ● B 3000K

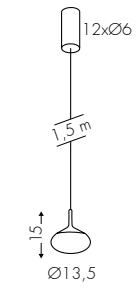

1082ATFBVE2B 6,5W 680lm* - 220V

310,00 €

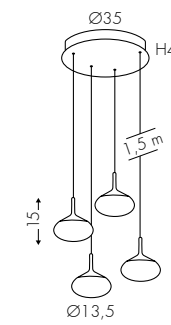

1082GTFBVE2B 4x6,5W 4x680lm - 220V

980,00 €

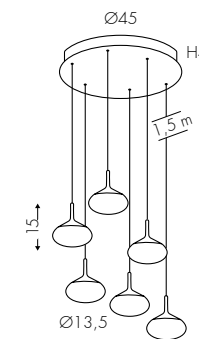

1082HTFBVE2B 6x6,5W 6x800lm - 220V

1.750,00 €

CO05T2NE Custom black cable

8,00 € /MT

Configura Configure / Konfigurieren

www.teamitaliailluminazione.it



● A 2700K



CODICE COMPLETO DEL PRODOTTO NELLA FOTO
FULL PRODUCT CODE AS SHOWN IN PICTURE - VOLLSTÄNDIGER CODE VOM ARTIKEL IM BILD

1082HTF **BF** **E2** **A**

Codice Code	Finitura Finishing Lackierung	Diffusore Diffuser Diffusor	Tonalità Hue Farbton
----------------	-------------------------------------	-----------------------------------	----------------------------

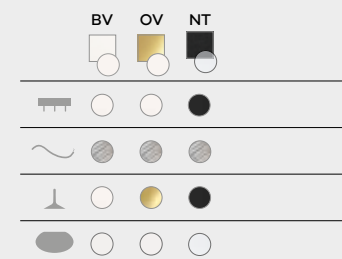

TF Taglio di Fase - Phase-Cut Dimmer - Phasenabschrittdimmer
A Alimentatore nel rosone - Power Supply inside the ceiling rose - Netzteil in der Deckendose

* 680lm effettivi - effective - effektive con - with - mit **E2**



OMNIA

OMNILIGHT

SOSPENSIONE
SUSPENSION LAMP
PENDELLEUCHE



configurazione standard: / basic configuration: / Standard Konfiguration:

E2 Opale - Opal - Opal B 3000K

BV

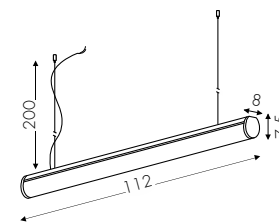

1065BBVE2B 25W 2856lm* - 24VDC **242,00 €**

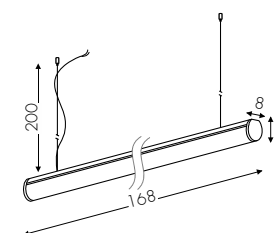

1065DBVE2B 37W 4290lm - 24VDC **276,00 €**

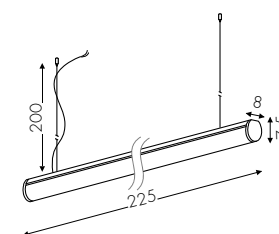

1065FBVE2B 50W 5738lm - 24VDC **321,00 €**

Configura

Configure / Konfigurieren

www.teamitaliailluminazione.it



A 2700K C 4000K

NE

CODICE COMPLETO DEL PRODOTTO NELLA FOTO
FULL PRODUCT CODE AS SHOWN IN PICTURE - VOLLSTÄNDIGER CODE VOM ARTIKEL IM BILD

1065D

Codice
Code

NE

Finitura
Finishing
Lackierung

E2

Diffusore
Diffuser
Diffusor

B

Tonalità
Hue
Farbton

BV

NE

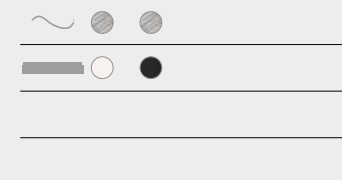

A Alimentatore 24VDC non incluso - Not Included 24VDC Driver
24VDC Netzteil nicht im Lieferumfang enthalten

Alimentatori a pag.132 - Power Supply p.132 - Netzteil p.132

* 2856lm effettivi - effective - effektive con - with - mit **E2**



configurazione standard: / basic configuration: / Standard Konfiguration:

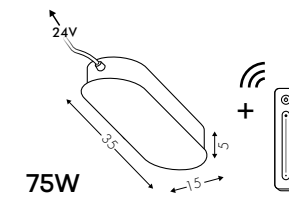

75W

9065TWA^{SDBV}

75W - 220V (24VDC) + SMART DIM Tunable White

212,00 €

BV

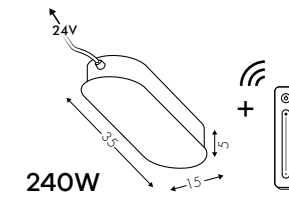

240W

9065TWC^{SDBV}

240W - 220V (24VDC) + SMART DIM Tunable White

307,00 €

Configura  Configure / Konfigurieren

www.teamitaliailluminazione.it 



NE

configurazione standard: / basic configuration: / Standard Konfiguration:

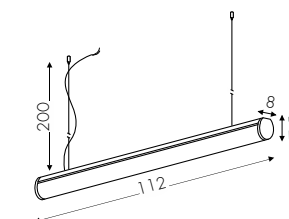

E2 Opale - Opal - Opal

 D 2700/6500K

BV

1065TWB^{BVE2D}

32W 3600lm* - 24VDC

279,00 €

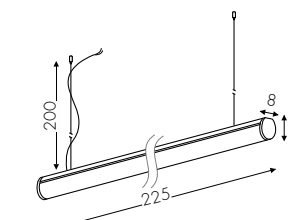

1065TWF^{BVE2D}

60W 6750lm - 24VDC

370,00 €

Configura  Configure / Konfigurieren

www.teamitaliailluminazione.it 



NE

6500K

2700K

 **CODICE COMPLETO DEL PRODOTTO NELLA FOTO**
FULL PRODUCT CODE AS SHOWN IN PICTURE - VOLLSTÄNDIGER CODE VOM ARTIKEL IM BILD

1065TWB

Codice
Code

BV

Finitura
Finishing
Lackierung

E2

Diffusore
Diffuser
Diffusor

D

Tonalità
Hue
Farbton

BV

NE

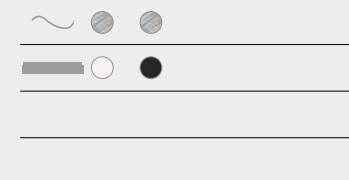

 Alimentatore 24VDC non incluso - Not Included 24VDC Driver
24VDC Netzteil nicht im Lieferumfang enthalten

Alimentatori a pag.132 - Drivers p.132 - Netzteil p.132

 Alimentatore Incorporato - Incorporated Power Supply - Eingebautes Netzteil

* 3600lm effettivi - effective - effektive con - with - mit **E2**

OVERLAP DECÒ

SOSPENSIONE
SUSPENSION LAMP
PENDELLEUCHE



configurazione standard: / basic configuration: / Standard Konfiguration:

E2 Opale - Opal

● B 3000K

BV

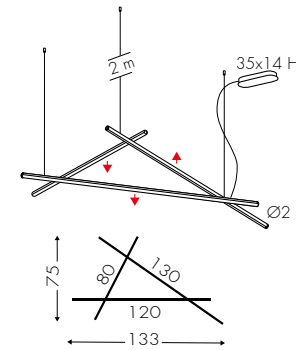

1015GTFBVE2B

75W 5500lm* - 220V

780,00 €

1015GDMBVE2B

DALI (Push) - 75W 5500lm - 220V

860,00 €

1015GSDBVE2B

75W 5500lm - 220V

860,00 €

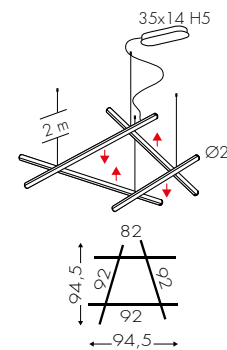

1015LTFBVE2B

78W 6000lm - 220V

780,00 €

1015LDMBVE2B

DALI (Push) - 78W 6000lm - 220V

860,00 €

1015LSDBVE2B

78W 6000lm - 220V

860,00 €

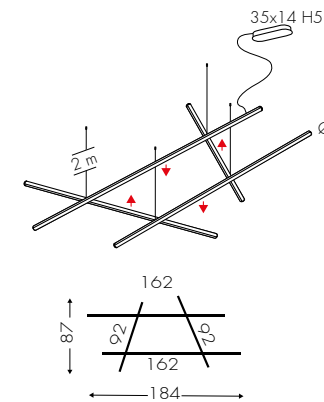

1015MTFBVE2B

110W 8500lm - 220V

890,00 €

1015MDMBVE2B

DALI (Push) - 110W 8500lm - 220V

970,00 €

1015MSDBVE2B

110W 8500lm - 220V

970,00 €

● C005T2NE

Custom black cable

8,00 € /MT

Configura

Configure / Konfigurieren

www.teamitaliailluminazione.it



A

● A 2700K



CODICE COMPLETO DEL PRODOTTO NELLA FOTO
FULL PRODUCT CODE AS SHOWN IN PICTURE - VOLLSTÄNDIGER CODE VOM ARTIKEL IM BILD

1015MTF **OV** **E2** **B**

Codice
Code

Finitura
Finishing
Lackierung

Diffusore
Diffuser
Diffusor

Tonalità
Hue
Farbton

BV NE RU OV BR RV



A Alimentatore nel rosone - Power Supply inside the ceiling rose - Netzteil in der Deckendose

TF Taglio di Fase - Phase-Cut Dimmer - Phasenabschnittdimmer

SD Telecomando radio - Smart Dimmer - Smart Dimmer

* 5500lm effettivi - effective - effektiven con - with - mit **E2**





PLENI

SOSPENSIONE
SUSPENSION LAMP
PENDELLEUCHTE



configurazione standard: / basic configuration: / Standard Konfiguration:

E2 Opale - Opal

B 3000K

BV

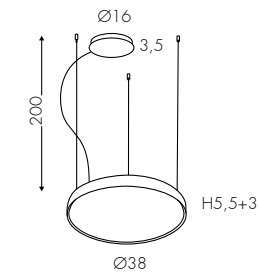

1067BOFBVE2B
1067BDMBVE2B

26W 3586lm* - 220V
DALI (Push) - 26W 3586lm - 220V

490,00 €
610,00 €

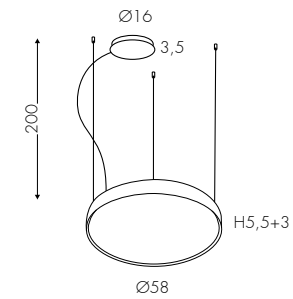

1067DOFBVE2B
1067DDMBVE2B

47W 6500lm - 220V
DALI (Push) - 47W 6500lm - 220V

675,00 €
775,00 €

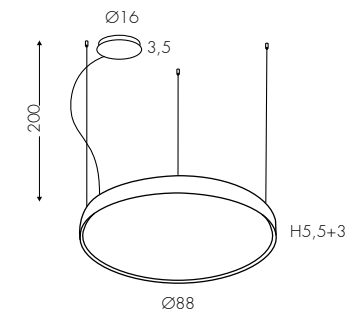

1067FOFBVE2B
1067FDMBVE2B

70W 8220lm - 220V
DALI (Push) - 70W 8220lm - 220V

970,00 €
1.070,00 €

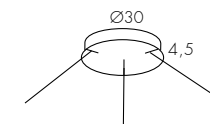

VAO03E

Variation: sostituzione con rosone centrale Ø30cm
Variation: substitution with central ceiling rose Ø30cm
Variante: Ersatz durch zentrale Deckenrose Ø30cm

100,00 €

Configura

Configure / Konfigurieren

www.teamitaliailluminazione.it



E19 UGR<19 Prism

C 4000K

NE



CODICE COMPLETO DEL PRODOTTO NELLA FOTO
FULL PRODUCT CODE AS SHOWN IN PICTURE - VOLLSTÄNDIGER CODE VOM ARTIKEL IM BILD

1067DOF **NE** **E2** **B**

Codice
Code

Finitura
Finishing
Lackierung

Diffusore
Diffuser
Diffusor

Tonalità
Hue
Farbton

BV



NE

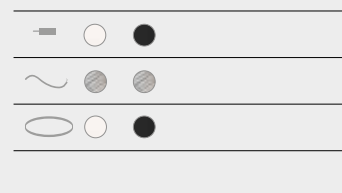

A Alimentatore Incorporato - Incorporated Power Supply - Eingebautes Netzteil

* 3586lm effettivi - effective - effektive con - with - mit **E2**
4220lm effettivi - effective - effektive con - with - mit **E19** **+17,5%**

SHADOW

SOSPENSIONE (composizione)
SUSPENSION (composition)
SUSPENSION (composition)



configurazione standard: / basic configuration: / Standard Konfiguration:

E2 Opale - Opal - Opal ● B 3000K

BV

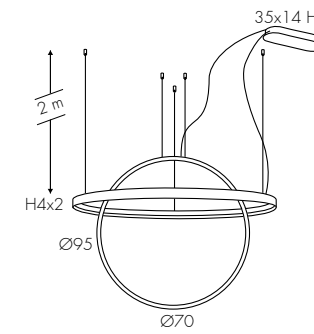

1068CHTFBVE2B
1068CHDMBVE2B

66W 5630lm* + 49W 3440lm 220V
DALI (Push) - 66W 5630lm + 49W 3440lm 220V

1.200,00 €
1.370,00 €

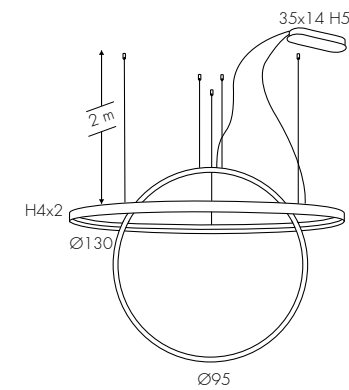

1068DITFBVE2B
1068DIDMBVE2B

90W 7750lm + 66W 3680lm 220V
DALI (Push) - 90W 7750lm + 66W 3680lm 220V

1.442,00 €
1.635,00 €

CO05T2NE Custom black cable

8,00 € /MT

Configura Configure / Konfigurieren

www.teamitaliailluminazione.it



● A 2700K

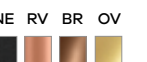

CODICE COMPLETO DEL PRODOTTO NELLA FOTO
FULL PRODUCT CODE AS SHOWN IN PICTURE - VOLLSTÄNDIGER CODE VOM ARTIKEL IM BILD

1068DITF **OV** **E2** **B**

Codice Code	Finitura Finishing Lackierung	Diffusore Diffuser Diffusor	Tonalità Hue Farbton
----------------	-------------------------------------	-----------------------------------	----------------------------

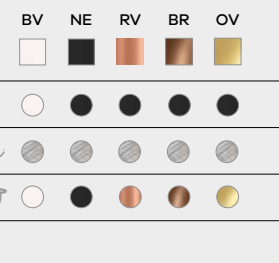

A Alimentatore nel rosone - Power Supply inside the ceiling rose - Netzteil in der Deckendose
TF Taglio di Fase - Phase-Cut Dimmer - Phasenabschrittdimmer

* 5630lm effettivi - effective - effektive con - with - mit **E2**

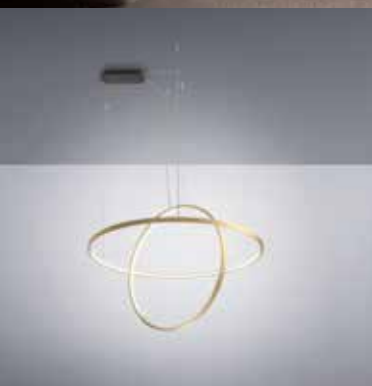



optional

E19

CODICE COMPLETO DEL PRODOTTO NELLA FOTO
FULL PRODUCT CODE AS SHOWN IN PICTURE · VOLLSTÄNDIGER CODE VOM ARTIKEL IM BILD

1069MTF PN E8 B

Codice Code	Finitura Finishing Lackierung	Diffusore Diffuser Diffusor	Tonalità Hue Farbton
----------------	-------------------------------------	-----------------------------------	----------------------------



standard

E8

CODICE COMPLETO · COMPLETE CODE · VOLLSTÄNDIGE CODE

1069TTF ON E8 B

Codice Code	Finitura Finishing Lackierung	Diffusore Diffuser Diffusor	Tonalità Hue Farbton
----------------	-------------------------------------	-----------------------------------	----------------------------

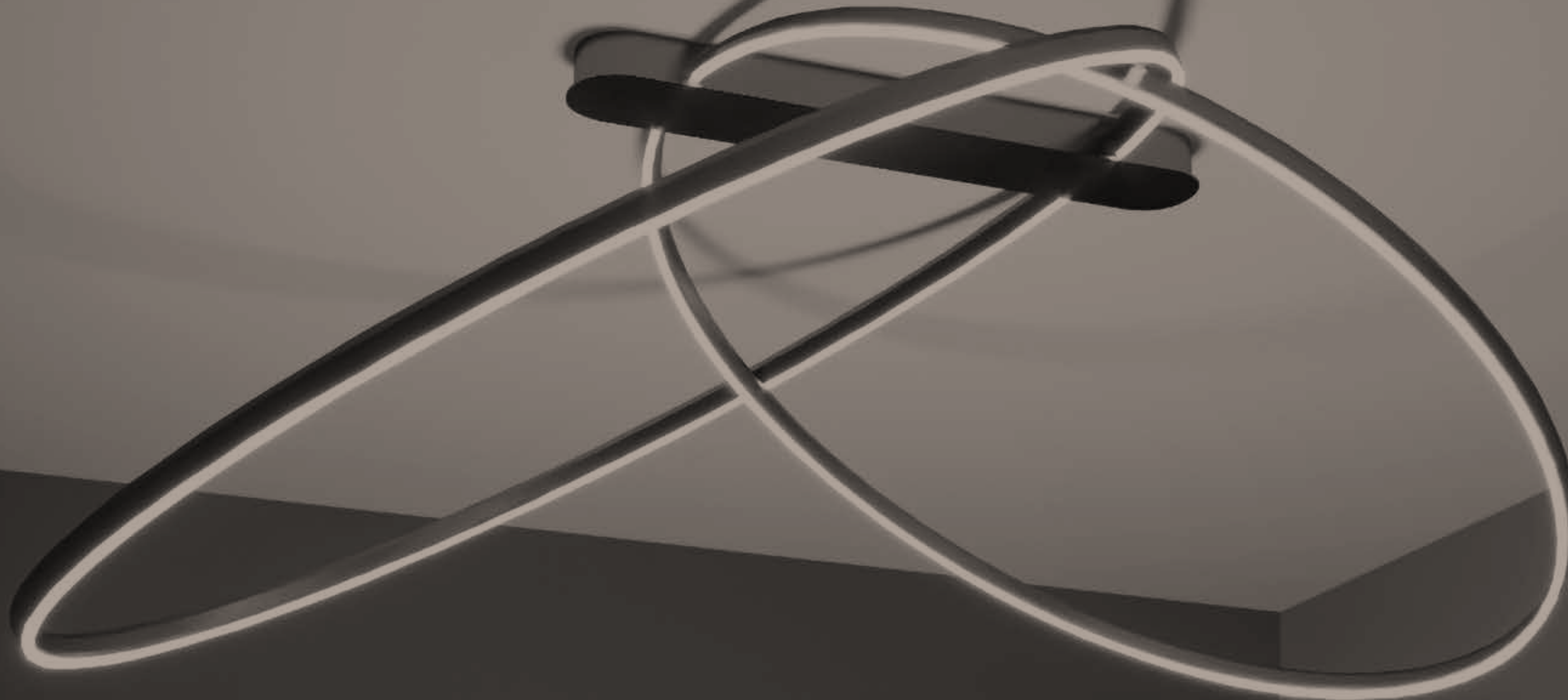

PLAFONE
CEILING LIGHT
DECKENLEUCHTE





configurazione standard: / basic configuration: / Standard Konfiguration:

E2 Opale - Opal

 B 3000K

BV

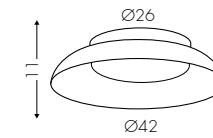

3087BTFBVE2B

18W 1620lm* - 220V

370,00 €

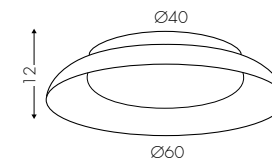

3087DTFBVE2B

30W 3000lm - 220V

495,00 €

Configura 

Configure / Konfigurieren

www.teamitaliailluminazione.it 



 **CODICE COMPLETO DEL PRODOTTO NELLA FOTO**
FULL PRODUCT CODE AS SHOWN IN PICTURE - VOLLSTÄNDIGER CODE VOM ARTIKEL IM BILD

3087D **TF** **OV** **E2** **B**

Codice
Code

Finitura
Finishing
Lackierung

Diffusore
Diffuser
Diffusor

Tonalità
Hue
Farbton

TF Taglio di Fase - Phase-Cut Dimmer - Phasenabschnittdimmer

A Alimentatore Incorporato - Incorporated Power Supply - Eingebautes Netzteil

* 1620lm effettivi - effective - effektiven con - with - mit **E2**





configurazione standard: / basic configuration: / Standard Konfiguration:

E2 Opale - Opal

● B 3000K

BV

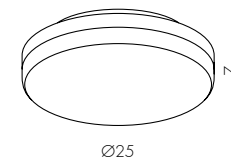

3080BOFBVE2B

12W 1300lm* - 220V

78,00 €

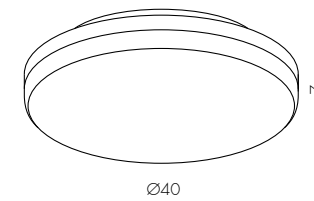

3080DOFBVE2B

30W 3000lm - 220V

148,00 €

Configura 

Configure / Konfigurieren

www.teamitaliailluminazione.it



BV



A Alimentatore Incorporato - Incorporated Power Supply - Eingebautes Netzteil

* 1300lm effettivi - effective - effektiven con - with - mit **E2**

 **CODICE COMPLETO DEL PRODOTTO NELLA FOTO**
FULL PRODUCT CODE AS SHOWN IN PICTURE - VOLLSTÄNDIGER CODE VOM ARTIKEL IM BILD

3080DOF **BV** **E2** **B**

Codice Code	Finitura Finishing Lackierung	Diffusore Diffuser Diffusor	Tonalità Hue Farbton
----------------	-------------------------------------	-----------------------------------	----------------------------



configurazione standard: / basic configuration: / Standard Konfiguration:

E2 Opale - Opal ● B 3000K

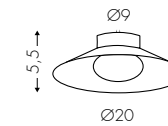

3076ATFNEE2B 10W 650lm* - 220V

198,00 €

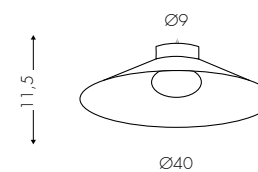

3076CTFNEE2B 17W 1100lm - 220V

315,00 €

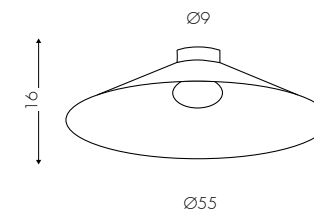

3076DTFNEE2B 17W 1100lm - 220V

368,00 €

Configura Configure / Konfigurieren

www.teamitaliailluminazione.it



● A 2700K



CODICE COMPLETO DEL PRODOTTO NELLA FOTO
FULL PRODUCT CODE AS SHOWN IN PICTURE - VOLLSTÄNDIGER CODE VOM ARTIKEL IM BILD

3076CTF **ZN** **E2** **A**

Codice Code	Finitura Finishing Lackierung	Diffusore Diffuser Diffusor	Tonalità Hue Farbton
----------------	-------------------------------------	-----------------------------------	----------------------------

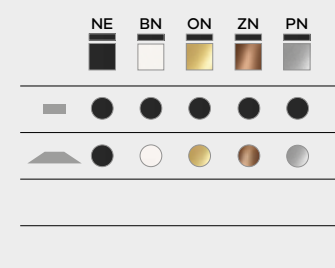

TF Taglio di Fase - Phase-Cut Dimmer - Phasenabschnittdimmer
A Alimentatore Incorporato - Incorporated Power Supply - Eingebautes Netzteil

* 650lm effettivi - effective - effektiven con - with - mit **E2**

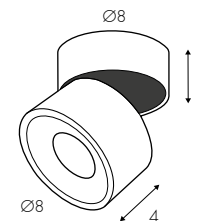

configurazione standard: / basic configuration: / Standard Konfiguration:

24° Ottica - Optic - Optik ● B 3000K

BV

3094AOFBV24B

1x10W 1100lm* - 220V

145,00 €

Configura  Configure / Konfigurieren

www.teamitaliailluminazione.it 



 **CODICE COMPLETO DEL PRODOTTO NELLA FOTO**
FULL PRODUCT CODE AS SHOWN IN PICTURE - VOLLSTÄNDIGER CODE VOM ARTIKEL IM BILD

3094AOF BN E24 B

Codice Code	Finitura Finishing Lackierung	Diffusore Diffuser Diffusor	Tonalità Hue Farbton
----------------	-------------------------------------	-----------------------------------	----------------------------

TF Taglio di Fase - Phase-Cut Dimmer - Phasenabschnittdimmer

A Alimentatore Incorporato - Incorporated Power Supply - Eingebautes Netzteil

* 1100lm effettivi - effective - effektiven con - with - mit **E2**



OKI

PLAFONE
CEILING LIGHT
DECKENLEUCHTE



configurazione standard: / basic configuration: / Standard Konfiguration:

E28 Satinato
Frosted - Satiniert

B 3000K

BV



3009OTFBVE28B

20W 1700lm* + 8W 950lm - 220V

286,00 €

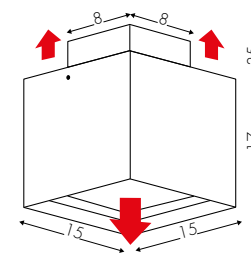

Configura

Configure / Konfigurieren

www.teamitaliailluminazione.it



A 2700K C 4000K

NE RU

CODICE COMPLETO DEL PRODOTTO NELLA FOTO
FULL PRODUCT CODE AS SHOWN IN PICTURE - VOLLSTÄNDIGER CODE VOM ARTIKEL IM BILD

3009OTF **NE** **E28** **B**

Codice
Code

Finitura
Finishing
Lackierung

Diffusore
Diffuser
Diffusor

Tonalità
Hue
Farbton

TF Taglio di Fase - Phase-Cut Dimmer - Erhältlich Phasenabschnittdimmer

A Alimentatore Incorporato - Incorporated Power Supply - Eingebautes Netzteil

* 1700lm effettivi - effective - effektive con - with - mit **E28**

OVERLAP DECÒ

PLAFONE
CEILING LIGHT
DECKENLEUCHE



configurazione standard: / basic configuration: / Standard Konfiguration:

E2 Opale - Opal

● B 3000K

BV

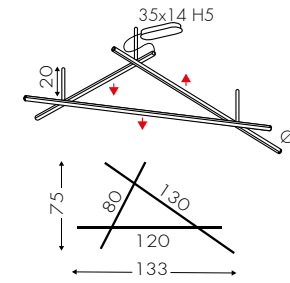

3015QTFBVE2B

75W 5500lm* - 220V

780,00 €

3015QDMBVE2B

DALI (Push) - 75W 5500lm - 220V

860,00 €

3015QSDBVE2B

75W 5500lm - 220V

860,00 €

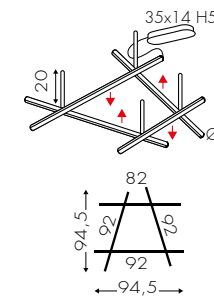

3015OTFBVE2B

78W 6000lm - 220V

780,00 €

3015ODMBVE2B

DALI (Push) - 78W 6000lm - 220V

860,00 €

3015OSDBVE2B

78W 6000lm - 220V

860,00 €

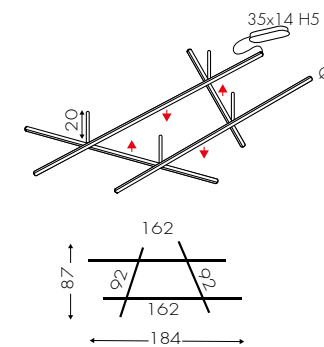

3015PTFBVE2B

110W 8500lm - 220V

890,00 €

3015PDMBVE2B

DALI (Push) - 110W 8500lm - 220V

970,00 €

3015PSDBVE2B

110W 8500lm - 220V

970,00 €

Configura

Configure / Konfigurieren

www.teamitaliailluminazione.it



A

● A 2700K

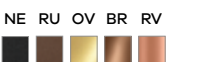

CODICE COMPLETO DEL PRODOTTO NELLA FOTO
FULL PRODUCT CODE AS SHOWN IN PICTURE - VOLLSTÄNDIGER CODE VOM ARTIKEL IM BILD

3015OTF BR E2 B

Codice Code	Finitura Finishing Lackierung	Diffusore Diffuser Diffusor	Tonalità Hue Farbton
----------------	-------------------------------------	-----------------------------------	----------------------------

BV NE RU OV BR RV

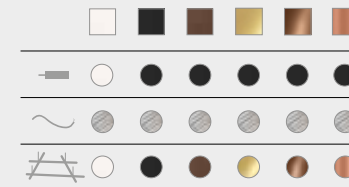

A Alimentatore nel rosone - Power Supply inside the ceiling rose - Netzteil in der Deckendose

TF Taglio di Fase - Phase-Cut Dimmer - Phasenabschnittdimmer

SD Telecomando radio - Smart Dimmer - Smart Dimmer

* 5500lm effettivi - effective - effektiven con - with - mit **E2**



PLENI

PLAFONE
CEILING LIGHT
DECKENLEUCHE



configurazione standard: / basic configuration: / Standard Konfiguration:

E2 Opale - Opal

B 3000K

BV

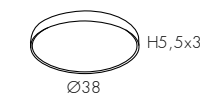

3067BOFBVE2B
3067BDMBVE2B

26W 3586lm* - 220V
DALI (Push) - 26W 3586lm - 220V

410,00 €
530,00 €

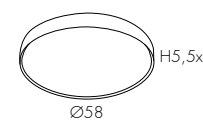

3067DOFBVE2B
3067DDMBVE2B

47W 6500lm - 220V
DALI (Push) - 47W 6500lm - 220V

595,00 €
695,00 €

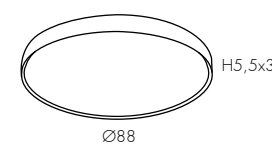

3067FOFBVE2B
3067FDMBVE2B

70W 8220lm - 220V
DALI (Push) - 70W 8220lm - 220V

890,00 €
990,00 €

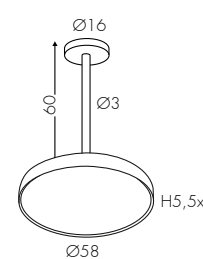

3067QOFBVE2B
3067QDMBVE2B

26W 3586lm - 220V
DALI (Push) - 26W 3586lm - 220V

675,00 €
775,00 €

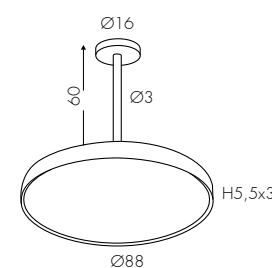

3067ROFBVE2B
3067RDMBVE2B

47W 6500lm - 220V
DALI (Push) - 47W 6500lm - 220V

970,00 €
1.070,00 €

Configura

Configure / Konfigurieren

www.teamitaliailluminazione.it



E19 UGR<19 Prism

C 4000K

NE



A Alimentatore Incorporato - Incorporated Power Supply - Eingebautes Netzteil

* 3586lm effettivi - effective - effektive con - with - mit **E2**
4220lm effettivi - effective - effektive con - with - mit **E19** +17,5%

CODICE COMPLETO DEL PRODOTTO NELLA FOTO
FULL PRODUCT CODE AS SHOWN IN PICTURE - VOLLSTÄNDIGER CODE VOM ARTIKEL IM BILD

3067BOF **NE** **E2** **B**

Codice
Code

Finitura
Finishing
Lackierung

Diffusore
Diffuser
Diffusor

Tonalità
Hue
Farbton





PIANTANA
FLOOR LAMP
STEHLAMPE





configurazione standard: / basic configuration: / Standard Konfiguration:

E19 UGR<19 Prism

B 3000K

BV



5028BDMBVE19B

DIM (Push) - 51W 4400lm* - 220V

925,00 €

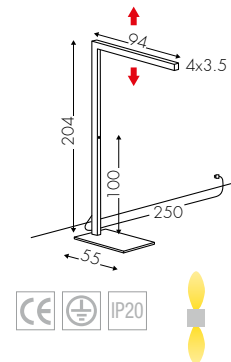
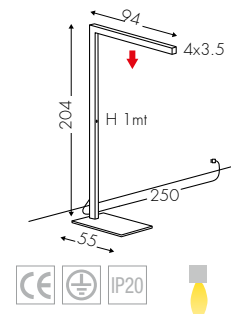

5028CDMBVE19B

DIM (Push) - down 51W 4400lm - up 20W 2200lm - 220V

955,00 €

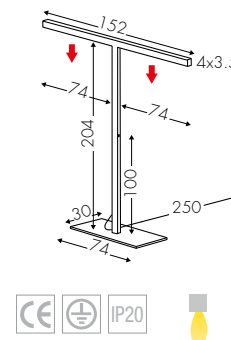

5028DDMBVE19B

DIM (Push) - down 2x32W 2x3500lm

1.530,00 €

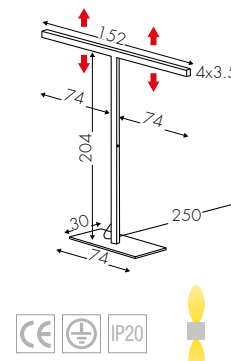

5028EDMBVE19B

DIM (Push) - down 2x32W 2x3500lm - up 2x12W 2x1200lm

1.730,00 €

Configura

Configure / Konfigurieren

www.teamitaliailluminazione.it

A 2700K C 4000K

NE RU



CODICE COMPLETO DEL PRODOTTO NELLA FOTO
FULL PRODUCT CODE AS SHOWN IN PICTURE - VOLLSTÄNDIGER CODE VOM ARTIKEL IM BILD

5028BDM **NE** **E19** **B**

Codice
Code

Finitura
Finishing
Lackierung

Diffusore
Diffuser
Diffusor

Tonalità
Hue
Farbton

Alimentatore Incorporato - Incorporated Power Supply - Eingebautes Netzteil

* 4400lm effettivi - effective - effektive con - with - mit **E19**



LAMBDA

PIANTANA
FLOOR LAMP
STEHLAMP 

configurazione standard: / basic configuration: / Standard Konfiguration:

E2 Opale - Opal

 B 3000K



5071EDPONE2B

35W 3800lm* - 220V

680,00 €

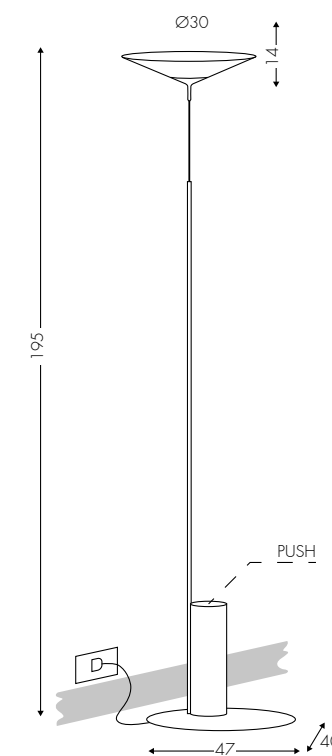

Configura 

Configure / Konfigurieren

www.teamitaliailluminazione.it 



 A 2700K



 CODICE COMPLETO DEL PRODOTTO NELLA FOTO
FULL PRODUCT CODE AS SHOWN IN PICTURE - VOLLSTÄNDIGER CODE VOM ARTIKEL IM BILD

5071EDP **ZN** **E2** **B**

Codice
Code

Finitura
Finishing
Lackierung

Diffusore
Diffuser
Diffusor

Tonalità
Hue
Farbton

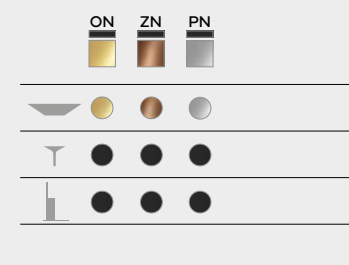

A Alimentatore Incorporato - Incorporated Power Supply - Eingebautes Netzteil
DP Dim Push

* 3800lm effettivi - effective - effektive con - with - mit **E2**

LAMBDA

PIANTANA
FLOOR LAMP
STEHLAMP 

configurazione standard: / basic configuration: / Standard Konfiguration:

E2 Opale - Opal  B 3000K 

5071CDPONE2B 9W 1200lm* - 220V

818,00 €

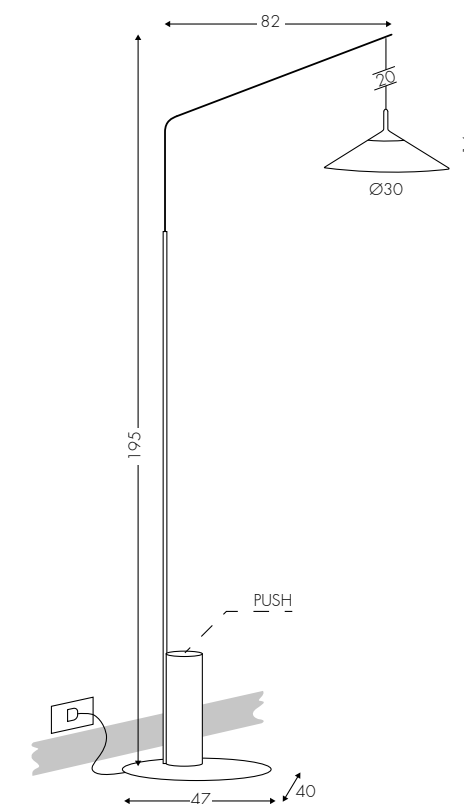

Configura  Configure / Konfigurieren

www.teamitaliailluminazione.it 



 A 2700K 

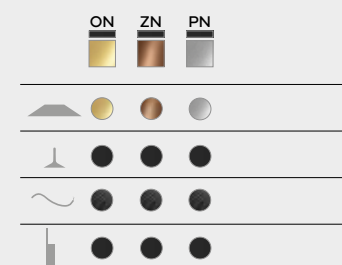

A Alimentatore Incorporato - Incorporated Power Supply - Eingebautes Netzteil
DP Dim Push

* 1200lm effettivi - effective - effektive con - with - mit **E2**



 **CODICE COMPLETO DEL PRODOTTO NELLA FOTO**
FULL PRODUCT CODE AS SHOWN IN PICTURE - VOLLSTÄNDIGER CODE VOM ARTIKEL IM BILD

5071CDP **ON** **E2** **B**
 Codice Code Finitura Finishing Lackierung Diffusore Diffuser Diffusor Tonalità Hue Farbton



LAMBDA

PIANTANA
FLOOR LAMP
STEHLAMP

configurazione standard: / basic configuration: / Standard Konfiguration:

E2 Opale - Opal B 3000K

5071DDPONE2B 9W 1200lm* - 220V

1.070,00 €

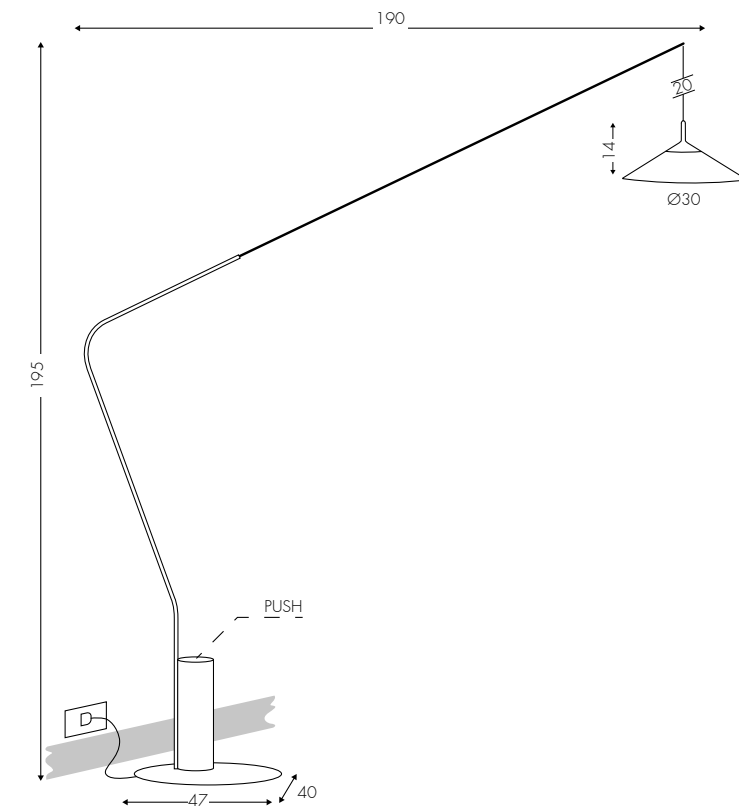

Configura

Configure / Konfigurieren

www.teamitaliailluminazione.it

A 2700K

CODICE COMPLETO DEL PRODOTTO NELLA FOTO
FULL PRODUCT CODE AS SHOWN IN PICTURE - VOLLSTÄNDIGER CODE VOM ARTIKEL IM BILD

5071DDP **PN** **E2** **B**

Codice
Code

Finitura
Finishing
Lackierung

Diffusore
Diffuser
Diffusor

Tonalità
Hue
Farbton

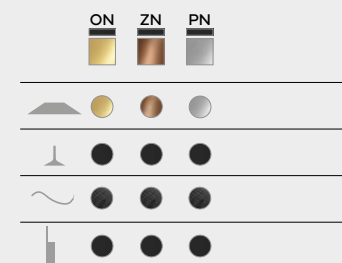

Alimentatore Incorporato - Incorporated Power Supply - Eingebautes Netzteil
 Dim Push

* 1200lm effettivi - effective - effektive con - with - mit E2

Incassi/recessed
Einbauleuchte





configurazione standard: / basic configuration: / Standard Konfiguration:

Ottica 45° (45)

B 3000K

BV

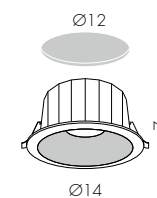

4089BOFBV45B
4089BDMBV45B

18W 1674lm* - 220V
DALI (Push) - 18W 1674lm - 220V

53,00 €
98,00 €

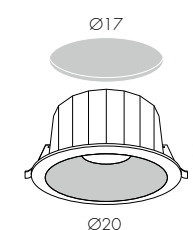

4089COFBV45B
4089CDMBV45B

36W 2800lm - 220V
DALI (Push) - 36W 2800lm - 220V

99,00 €
144,00 €

Configura

Configure / Konfigurieren

www.teamitaliailluminazione.it



C 4000K

BV

Alimentatore incluso in remoto - Included Power Supply in remote - Fernspeisung enthalten

* 1674lm effettivi - effective - effektive con - with - mit E2

CODICE COMPLETO DEL PRODOTTO NELLA FOTO
FULL PRODUCT CODE AS SHOWN IN PICTURE - VOLLSTÄNDIGER CODE VOM ARTIKEL IM BILD

4089COF **BV** **45** **B**

Codice
Code

Finitura
Finishing
Lackierung

Diffusore
Diffuser
Diffusor

Tonalità
Hue
Farbton





configurazione standard: / basic configuration: / Standard Konfiguration:

24° Ottica - Optic - Optik ● B 3000K

BV

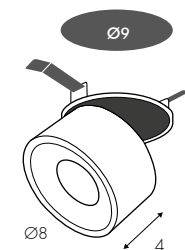

4094AOFBV24B
4094ADMBV24B

1x8W 900lm* - 220V
DALI (Push) - 1x8W 900lm - 220V

125,00 €
145,00 €

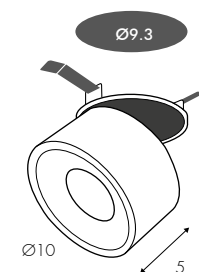

4094BOFBV24B
4094BDMBV24B

1x14W 1200lm - 220V
DALI (Push) - 1x14W 1200lm - 220V

135,00 €
155,00 €



Configura

Configure / Konfigurieren

www.teamitaliailluminazione.it



CODICE COMPLETO DEL PRODOTTO NELLA FOTO
FULL PRODUCT CODE AS SHOWN IN PICTURE - VOLLSTÄNDIGER CODE VOM ARTIKEL IM BILD

4094AOF **BN** **E24** **B**

Codice Code	Finitura Finishing Lackierung	Diffusore Diffuser Diffusor	Tonalità Hue Farbton
----------------	-------------------------------------	-----------------------------------	----------------------------

TF Taglio di Fase - Phase-Cut Dimmer - Phasenabschnittdimmer

A Alimentatore Incorporato - Incorporated Power Supply - Eingebautes Netzteil

* 900lm effettivi - effective - effektiven con - with - mit **E2**

Profili/Profiles/Profile

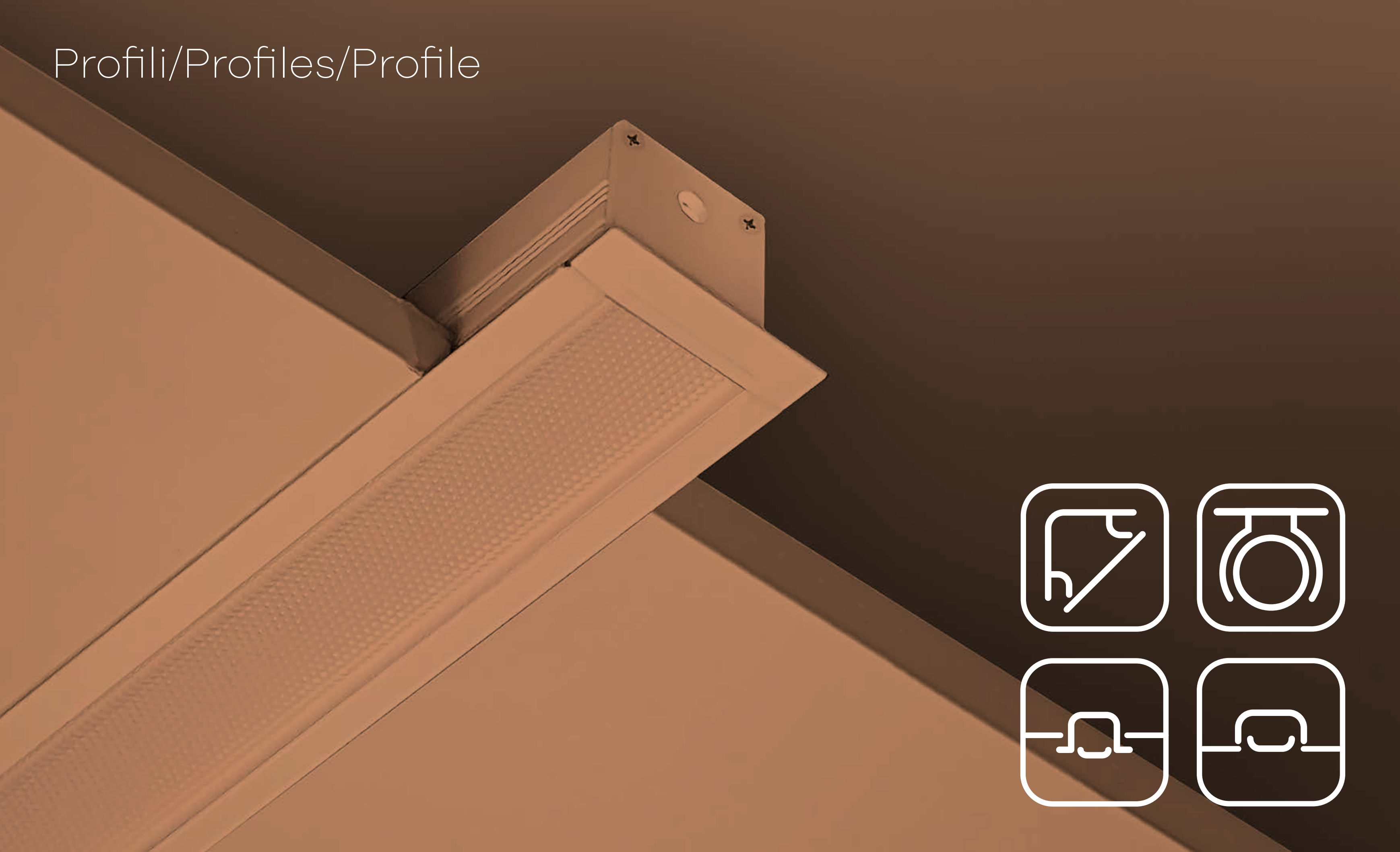



SV custom finish

PROFILI

3092Z0 - PLAFONE MID

BV

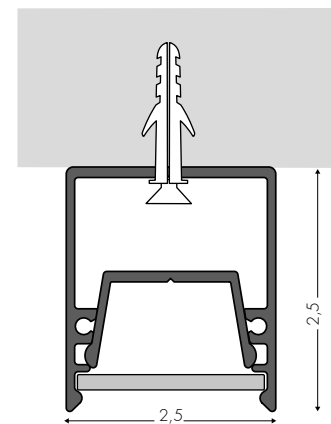

3092Z0MT1	profile 100 cm (NO LED)	60,00 €
3092Z0MT2	profile 200 cm (NO LED)	120,00 €
3092Z0MT3	profile 300 cm (NO LED)	170,00 €

 E2 Opale - Opal

 Led non incluso - Led not included - Led nicht inbegriffen

 Alimentatore non incluso - Power Supply not included - Netzteil nicht inbegriffen

SERVIZIO SU MISURA

001001A

Taglio Profilo - Cut service

10,00 €



CODICE COMPLETO • COMPLETE CODE • VOLLSTÄNDIGE CODE

3092Z0MT2 **BV** **E2** + **001001A**

Codice
Code
Code

Finitura
Finishing
Lackierung

Diffusore
Diffuser
Diffusor

SERVICE

Outdoor

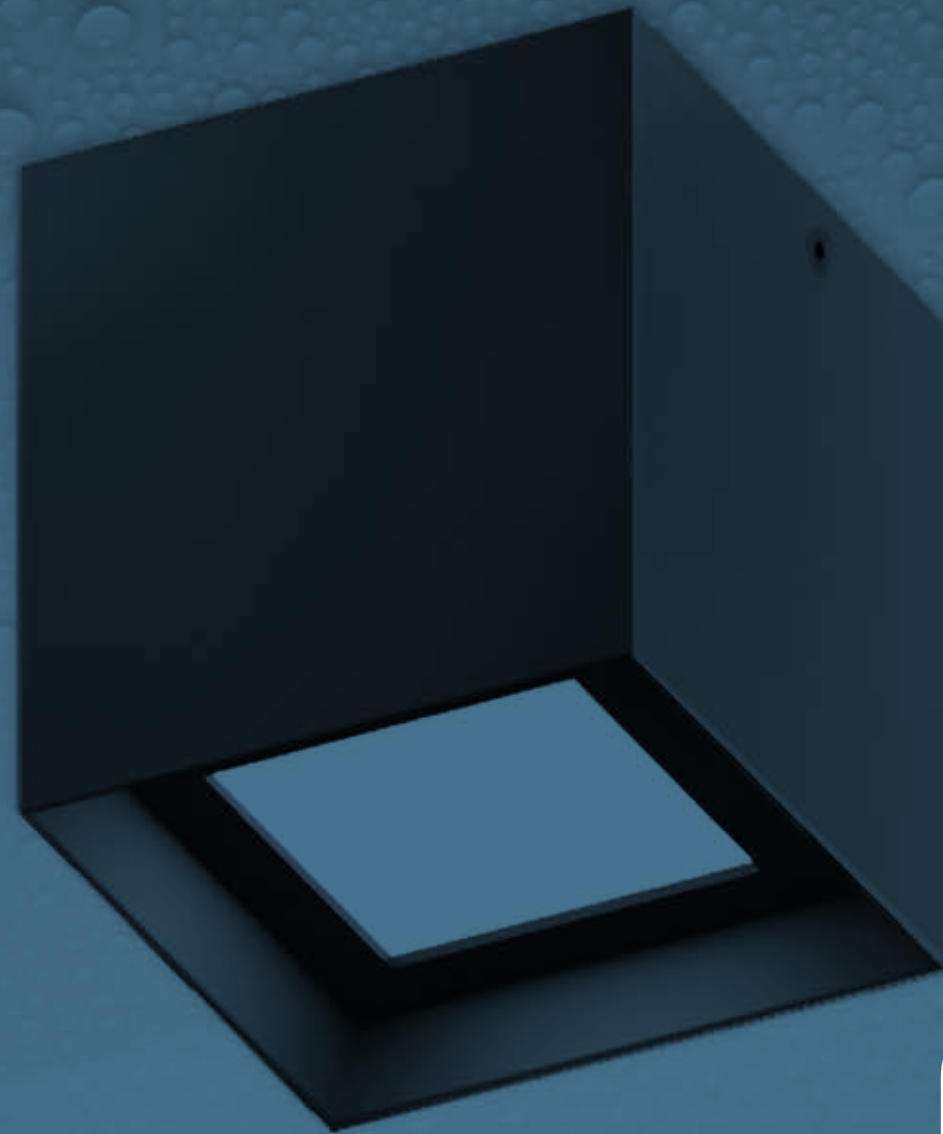

MIRÓ IP54 DOWNLIGHT (1-10mt)

SOSPENSIONE
SUSPENSION LAMP
PENDELLEUCHTE



configurazione standard: / basic configuration: / Standard Konfiguration:

E2 Opale - Opal

B 3000K

BV

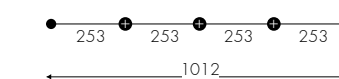
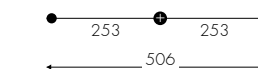
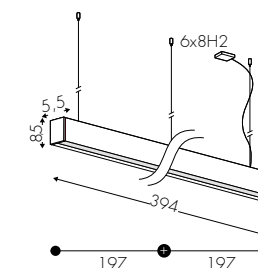
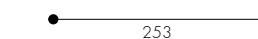
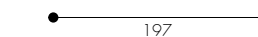
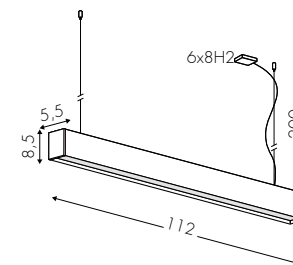

1085BOFBVE2B 25W 1910lm* - 220V **357,00 €**
1085BDMBVE2B DALI (Push) - 25W 1910lm - 220V **413,00 €**

1085EOFBVE2B 44W 3350lm - 220V **461,00 €**
1085EDMBVE2B DALI (Push) - 44W 3350lm - 220V **522,00 €**

1085GOFBVE2B 56W 4305lm - 220V **569,00 €**
1085GDMBVE2B DALI (Push) - 56W 4305lm - 220V **616,00 €**

1085LOFBVE2B 87W 6705lm - 220V **1.001,00 €**
1085LDMBVE2B DALI (Push) - 87W 6705lm - 220V **1.150,00 €**

1085MOFBVE2B 111W 8605lm - 220V **1.174,00 €**
1085MDMBVE2B DALI (Push) - 111W 8605m - 220V **1.291,00 €**

1085ROFBVE2B 223W 17210lm - 220V **2.593,00 €**
1085RDMBVE2B DALI (Push) - 223W 17210lm - 220V **2.848,00 €**

Configura

Configure / Konfigurieren

www.teamitaliailluminazione.it



C 4000K

NE



A Alimentatore Incorporato - Incorporated Power Supply - Eingebautes Netzteil

* 1910lm effettivi - effective - effektive con - with - mit E2

CODICE COMPLETO DEL PRODOTTO NELLA FOTO
FULL PRODUCT CODE AS SHOWN IN PICTURE
VOLLSTÄNDIGER CODE VOM ARTIKEL IM BILD

1085EOF **NE** **E2** **B**

Codice
Code

Finitura
Finishing
Lackierung

Diffusore
Diffuser
Diffusor

Tonalità
Hue
Farbton

BV

NE

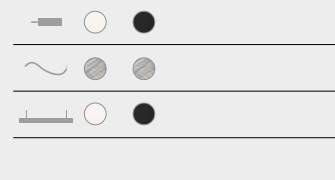

MIRÓ IP54

PLAFONE
CEILING LIGHT
DECKENLEUCHTE



configurazione standard: / basic configuration: / Standard Konfiguration:

E2 Opale - Opal

B 3000K

BV

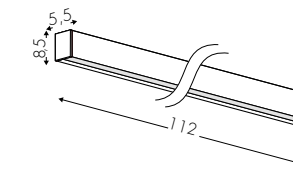

3085BOFBVE2B
3085BDMBVE2B

25W 1910lm* - 220V
DALI (Push) - 25W 1910lm - 220V

355,00 €
410,00 €



3085EOFBVE2B
3085EDMBVE2B

44W 3350lm - 220V
DALI (Push) - 44W 3350lm - 220V

482,00 €
542,00 €

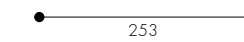

3085GOFBVE2B
3085GDMBVE2B

56W 4305lm - 220V
DALI (Push) - 56W 4305lm - 220V

589,00 €
636,00 €

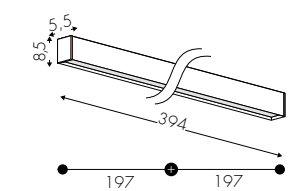

3085LOFBVE2B
3085LDMBVE2B

87W 6705lm - 220V
DALI (Push) - 87W 6705lm - 220V

1.059,00 €
1.209,00 €



3085MOFBVE2B
3085MDMBVE2B

111W 8605lm - 220V
DALI (Push) - 111W 8605lm - 220V

1.224,00 €
1.342,00 €



3085ROFBVE2B
3085RDMBVE2B

124W 17210lm - 220V
DALI (Push) - 124W 17210lm - 220V

2.607,00 €
2.943,00 €

Configura

Configure / Konfigurieren

www.teamitaliailluminazione.it



C 4000K

NE



A Alimentatore Incorporato - Incorporated Power Supply - Eingebautes Netzteil

* 1910lm effettivi - effective - effektive con - with - mit **E2**



↑ CODICE COMPLETO DEL PRODOTTO NELLA FOTO
FULL PRODUCT CODE AS SHOWN IN PICTURE
VOLLSTÄNDIGER CODE VOM ARTIKEL IM BILD

3085EOF **NE** **E2** **B**

Codice Code	Finitura Finishing Lackierung	Diffusore Diffuser Diffusor	Tonalità Hue Farbton
----------------	-------------------------------------	-----------------------------------	----------------------------





configurazione standard: / basic configuration: / Standard Konfiguration:

E2 Opale - Opal ● B 3000K

BV

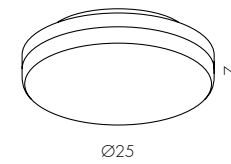

3080BOFBVE2B

12W 1300lm* - 220V

78,00 €

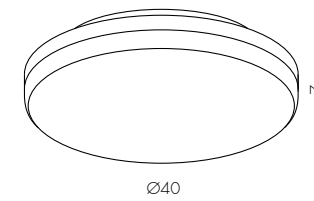

3080DOFBVE2B

30W 3000lm - 220V

148,00 €

Configura 

Configure / Konfigurieren

www.teamitaliailluminazione.it 



A Alimentatore Incorporato - Incorporated Power Supply - Eingebautes Netzteil

* 1300lm effettivi - effective - effektiven con - with - mit **E2**

 **CODICE COMPLETO DEL PRODOTTO NELLA FOTO**
FULL PRODUCT CODE AS SHOWN IN PICTURE - VOLLSTÄNDIGER CODE VOM ARTIKEL IM BILD

3080DOF **BV** **E2** **B**

Codice Code	Finitura Finishing Lackierung	Diffusore Diffuser Diffusor	Tonalità Hue Farbton
----------------	-------------------------------------	-----------------------------------	----------------------------



WET PLUS+

PLAFONE
CEILING LIGHT
DECKENLEUCHE



configurazione standard: / basic configuration: / Standard Konfiguration:

E2 Opale - Opal

C 4000K

GV

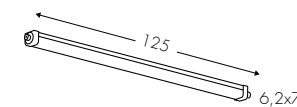

3079BOFGVE2C
3079BDMGVE2C

48W 6500lm* - 220V

DALI (Push) - 50W 5900lm - 220V

134,00 €

157,00 €

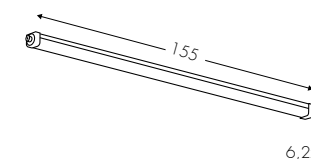

3079COFGVE2C
3079CDMGVE2C

75W 10000lm - 220V

DALI (Push) - 60W 8200lm - 220V

157,00 €

318,00 €

Configura

Configure / Konfigurieren

www.teamitaliailluminazione.it



CODICE COMPLETO DEL PRODOTTO NELLA FOTO
FULL PRODUCT CODE AS SHOWN IN PICTURE - VOLLSTÄNDIGER CODE VOM ARTIKEL IM BILD

3079BOF

Codice
Code

GV

Finitura
Finishing
Lackierung

E2

Diffusore
Diffuser
Diffusor

C

Tonalità
Hue
Farbton

Alimentatore Incorporato - Incorporated Power Supply - Eingebautes Netzteil

* 6500lm effettivi - effective - effektive con - with - mit **E2**

Sistemi modulari
Modular systems
Modulare Systeme



EMME 24 DOWNLIGHT (3-10mt)

SOSPENSIONE
SUSPENSION LAMP
PENDELLEUCHTE



configurazione standard: / basic configuration: / Standard Konfiguration:

E2 Opale - Opal

B 3000K

BV

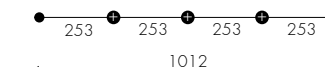
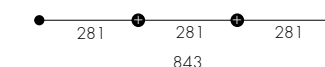
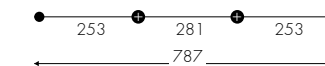
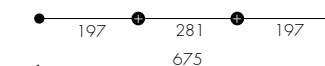
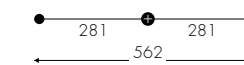
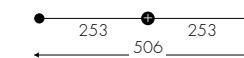
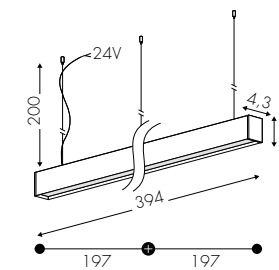

1037LBVE2B

87W 6705lm* - 24VDC

700,00 €

1037MBVE2B

111W 8605lm - 24VDC

760,00 €

1037NBVE2B

124W 9560lm - 24VDC

873,00 €

1037OBVE2B

148,5W 11485lm - 24VDC

1.157,00 €

1037PBVE2B

173W 13380lm - 24VDC

1.298,00 €

1037QBVE2B

185W 14340lm - 24VDC

1.358,00 €

1037RBVE2B

223W 17210lm - 24VDC

1.743,00 €

Configura

Configure / Konfigurieren

www.teamitaliailluminazione.it



E19 UGR<19 Prism

C 4000K

NE



CODICE COMPLETO DEL PRODOTTO NELLA FOTO
FULL PRODUCT CODE AS SHOWN IN PICTURE - VOLLSTÄNDIGER CODE VOM ARTIKEL IM BILD

1037KGR **NE** **E2** **B**

Codice
Code

Finitura
Finishing
Lackierung

Diffusore
Diffuser
Diffusor

Tonalità
Hue
Farbton

Alimentatore non incluso - Power Supply not included - Netzteil nicht inbegriffen

Alimentatori a pag. 564-565 - Drivers p. 564-565 - Netzteil p. 564-565

* 6705lm effettivi - effective - effektive con - with - mit E2
7880lm effettivi - effective - effektive con - with - mit E19 +17,5%

KIT DRIVER

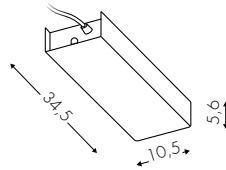

0-3 METRI

9037AOF 75W - 220V
9037ADM DALI (Push) - 75W - 220V
9037ATF 75W - 220V

130,00 €
218,00 €
179,00 €

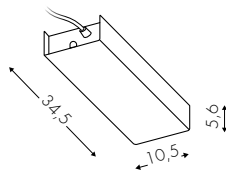

3-6 METRI

9037BOF 150W - 220V
9037BDM DALI (Push) - 150W - 220V
9037BTF 150W - 220V

174,00 €
262,00 €
221,00 €

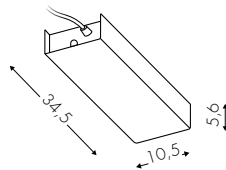

6-11 METRI

9037COF 240W - 220V
9037CDM DALI (Push) - 240W - 220V

228,00 €
318,00 €

BV NE

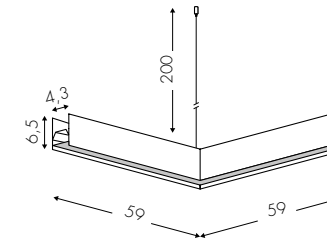

configurazione standard: / basic configuration: / Standard Konfiguration:

E2 Opale - Opal B 3000K

BV



1037KGABVE2B 25W 1905lm* - 24VDC **345,00 €**

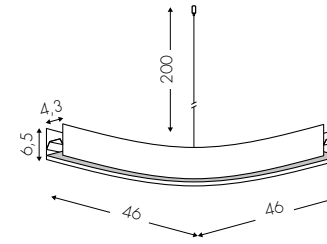

1037KGRBVE2B 18W 1235lm - 24VDC **345,00 €**



A Alimentatore Incorporato - Incorporated Power Supply - Eingebautes Netzteil



E19 UGR<19 Prism C 4000K

Configura

Configure / Konfigurieren

www.teamitaliailluminazione.it

NE



A Alimentatore non incluso - Power Supply not included - Netzteil nicht inbegriffen
Alimentatori a pag. 564-565 - Drivers p. 564-565 - Netzteil p. 564-565

* 1905lm effettivi - effective - effektive con - with - mit **E2**
 2240lm effettivi - effective - effektive con - with - mit **E19** **+17,5%**



configurazione standard: / basic configuration: / Standard Konfiguration:

E2 Opale - Opal ● B 3000K

BV

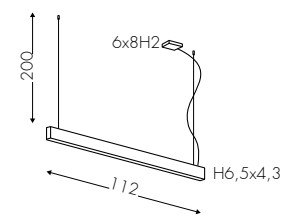

1058BOFBVE2B 18W 2025lm* + 8W 1100lm - 220V **304,00 €**
1058BDMBVE2B DALI (Push) - 18W 2025lm + 8W 1100lm - 220V **365,00 €**



1058COFBVE2B 22W 2530lm + 8W 1100lm - 220V **329,00 €**
1058CDMBVE2B DALI (Push) - 22W 2530lm + 8W 1100lm - 220V **388,00 €**



1058DOFBVE2B 26W 3040lm + 16W 2200lm - 220V **356,00 €**
1058DDMBVE2B DALI (Push) - 26W 3040lm + 16W 2200lm - 220V **430,00 €**

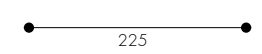

1058EOFBVE2B 31W 3540lm + 16W 2200lm - 220V **376,00 €**
1058EDMBVE2B DALI (Push) - 31W 3540lm + 16W 2200lm - 220V **430,00 €**

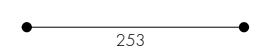

1058FOFBVE2B 34W 4010lm + 16W 2200lm - 220V **424,00 €**
1058FDMBVE2B DALI (Push) - 34W 4010lm + 16W 2200lm - 220V **498,00 €**



1058GOFBVE2B 39W 4520lm + 16W 2200lm - 220V **463,00 €**
1058GDMBVE2B DALI (Push) - 39W 4520lm + 16W 2200lm - 220V **534,00 €**

1058HOFBVE2B 43W 5080lm + 16W 2200lm - 220V **530,00 €**
1058HDMBVE2B DALI (Push) - 43W 5080lm + 16W 2200lm - 220V **604,00 €**

Configura

Configure / Konfigurieren

www.teamitaliailluminazione.it

CE IP20

E19 UGR<19 Prism ● A 2700K C 4000K

NE RU

CODICE COMPLETO DEL PRODOTTO NELLA FOTO
FULL PRODUCT CODE AS SHOWN IN PICTURE - VOLLSTÄNDIGER CODE VOM ARTIKEL IM BILD

1058DOF **NE** **E2** **B**

Codice Code Finitura Finishing Diffusore Diffuser Tonalità Hue
 Code Lackierung Diffusor Farbton

BV NE RU

Alimentatore Incorporato - Incorporated Power Supply - Eingebautes Netzteil

* 2025lm effettivi - effective - effektive con - with - mit **E2**
 2380lm effettivi - effective - effektive con - with - mit **E19** **+17,5%**



configurazione standard: / basic configuration: / Standard Konfiguration:

E2 Opale - Opal

B 3000K

BV

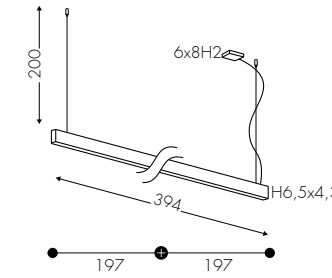

1058LOFBVE2B
1058LDMBVE2B

62W 7080lm* + 32W 4400lm - 220V
DALI (Push) - 62W 7080lm + 32W 4400lm - 220V

766,00 €
877,00 €



1058MOFBVE2B
1058MDMBVE2B

78W 9010lm + 32W 4400lm - 220V
DALI (Push) - 78W 9010lm + 32W 4400lm - 220V

944,00 €
1.088,00 €

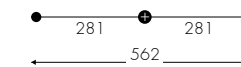

1058NOFBVE2B
1058NDMBVE2B

86W 10155lm + 32W 4400lm - 220V
DALI (Push) - 86W 10155lm + 32W 4400lm - 220V

1.080,00 €
1.231,00 €

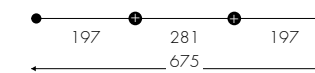

1058OOFBVE2B
1058ODMBVE2B

105W 12160lm + 48W 6600lm - 220V
DALI (Push) - 105W 12160lm + 48W 6600lm - 220V

1.306,00 €
1.492,00 €

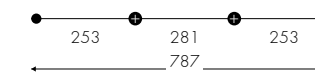

1058POFBVE2B
1058PDMBVE2B

121W 14095lm + 48W 6600lm - 220V
DALI (Push) - 121W 14095lm + 48W 6600lm - 220V

1.483,00 €
1.704,00 €

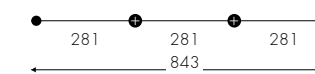

1058QOFBVE2B
1058QDMBVE2B

129W 15230lm + 48W 6600lm - 220V
DALI (Push) - 129W 15230lm + 48W 6600lm - 220V

1.620,00 €
1.847,00 €

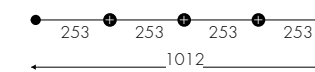

1058ROFBVE2B
1058RDMBVE2B

156W 18030lm + 64W 8800lm - 220V
DALI (Push) - 156W 18030lm + 64W 8800lm - 220V

1.887,00 €
2.176,00 €

Configura

Configure / Konfigurieren

www.teamitaliailluminazione.it



E19 UGR<19 Prism

A 2700K C 4000K

NE RU

CODICE COMPLETO DEL PRODOTTO NELLA FOTO
FULL PRODUCT CODE AS SHOWN IN PICTURE - VOLLSTÄNDIGER CODE VOM ARTIKEL IM BILD

1058OOF **NE** **E2** **B**

Codice
Code

Finitura
Finishing
Lackierung

Diffusore
Diffuser
Diffusor

Tonalità
Hue
Farbton

BV NE RU

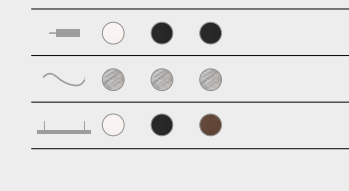

A Alimentatore Incorporato - Incorporated Power Supply - Eingebautes Netzteil

* 7080lm effettivi - effective - effektive con - with - mit **E2**
8330lm effettivi - effective - effektive con - with - mit **E19** **+17,5%**



configurazione standard: / basic configuration: / Standard Konfiguration:

E2 Opale - Opal

B 3000K

BV

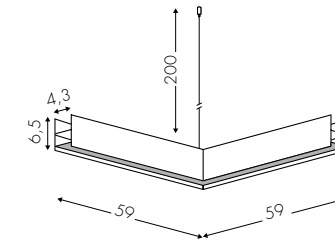

1058KGAOFBVE2B

18W 2025lm* - 220V

454,00 €

1058KGADMBVE2B

DALI (Push) - 18W 2025lm - 220V

520,00 €

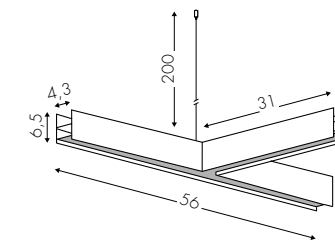

1058KGT OFBVE2B

14W 1575lm - 220V

563,00 €

1058KGTDMBVE2B

DALI (Push) - 14W 1575lm - 220V

634,00 €

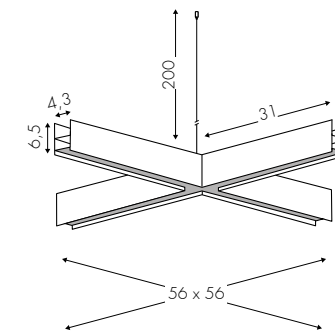

1058KGC OFBVE2B

18W 2025lm - 220V

741,00 €

1058KGC DMBVE2B

DALI (Push) - 18W 2025lm - 220V

817,00 €

Configura

Configure / Konfigurieren

www.teamitaliailluminazione.it



E19 UGR<19 Prism

A 2700K C 4000K

NE RU

CODICE COMPLETO DEL PRODOTTO NELLA FOTO
FULL PRODUCT CODE AS SHOWN IN PICTURE - VOLLSTÄNDIGER CODE VOM ARTIKEL IM BILD

1058GAOF **NE** **E2** **B**

Codice
Code

Finitura
Finishing
Lackierung

Diffusore
Diffuser
Diffusor

Tonalità
Hue
Farbton

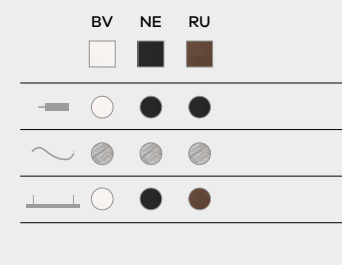

A Alimentatore Incorporato - Incorporated Power Supply - Eingebautes Netzteil

* 2025lm effettivi - effective - effektive con - with - mit **E2**
2380lm effettivi - effective - effektive con - with - mit **E19** **+17,5%**



MIRÓ INCASSO

INCASSO
RECESSED LIGHT
EINBAULEUCHTE



configurazione standard: / basic configuration: / Standard Konfiguration:

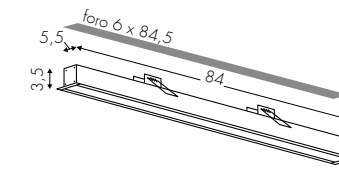

E2 Opale

● B 3000K

BV

4030AOFBVE2B 26W 2260lm* - 220V **329,00 €**
4030ADMBVE2B DALI(Push) 26W 2260lm - 220V **374,00 €**

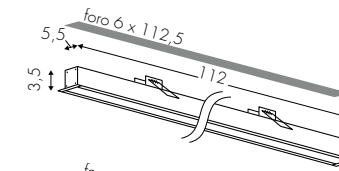

4030BOFBVE2B 35W 3010lm - 220V **336,00 €**
4030BDMBVE2B DALI(Push) 35W 3010lm - 220V **391,00 €**

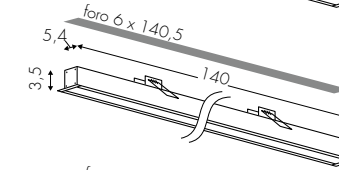

4030COFBVE2B 44W 3765lm - 220V **379,00 €**
4030CDMBVE2B DALI(Push) 44W 3765lm - 220V **435,00 €**

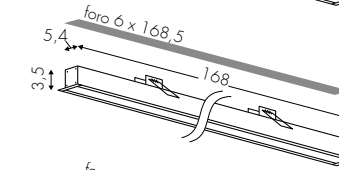

4030DOFBVE2B 53W 4515lm - 220V **395,00 €**
4030DDMBVE2B DALI(Push) 53W 4515lm - 220V **464,00 €**

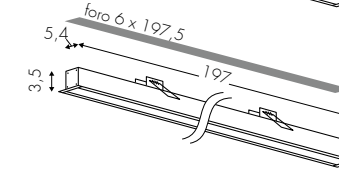

4030EOFBVE2B 62W 5265lm - 220V **411,00 €**
4030EDMBVE2B DALI(Push) 62W 5265lm - 220V **469,00 €**

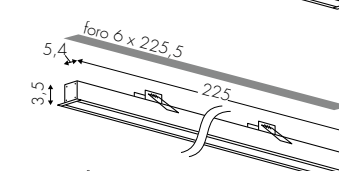

4030FOFBVE2B 70W 6020lm - 220V **508,00 €**
4030FDMBVE2B DALI(Push) 70W 6020lm - 220V **567,00 €**

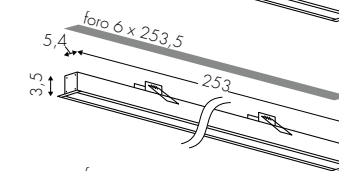

4030GOFBVE2B 79W 6775lm - 220V **566,00 €**
4030GDMBVE2B DALI(Push) 79W 6775lm - 220V **641,00 €**

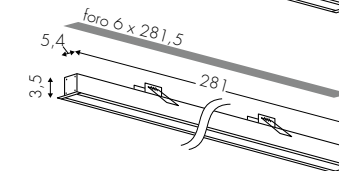

4030HOFBVE2B 88W 7525lm - 220V **613,00 €**
4030HDMBVE2B DALI(Push) 88W 7525lm - 220V **660,00 €**

Configura Configura / Konfigurieren

www.teamitaliailluminazione.it



Opal **E19** UGR<19 Prism **C** 4000K

NE

CODICE COMPLETO DEL PRODOTTO NELLA FOTO
FULL PRODUCT CODE AS SHOWN IN PICTURE - VOLLSTÄNDIGER CODE VOM ARTIKEL IM BILD

4030DOF **BV** **E2** **B**

Codice
Code

Finitura
Finishing
Lackierung

Diffusore
Diffuser
Diffusor

Tonalità
Hue
Farbton

Alimentatore Incluso in remoto - Remote Power Supply - Fernspeisung enthalten

* 2260lm effettivi - effective - effektive con - with - mit **E2**
 2655lm effettivi - effective - effektive con - with - mit **E19** **+17,5%**



configurazione standard: / basic configuration: / Standard Konfiguration:

E2 Opale

● B 3000K

BV

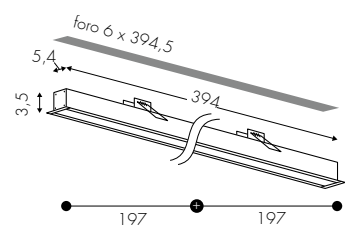

4030LOFBVE2B
4030LDMBVE2B

123W 10530lm - 220V
DALI(Push) 123W 10530lm - 220V

822,00 €
937,00 €

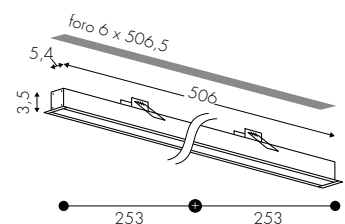

4030MOFBVE2B
4030MDMBVE2B

158W 13550lm - 220V
DALI(Push) 158W 13550lm - 220V

1.132,00 €
1.281,00 €

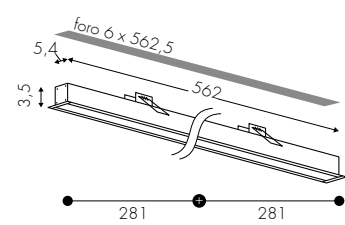

4030NOFBVE2B
4030NDMBVE2B

176W 15050lm - 220V
DALI(Push) 176W 15050lm - 220V

1.225,00 €
1.320,00 €

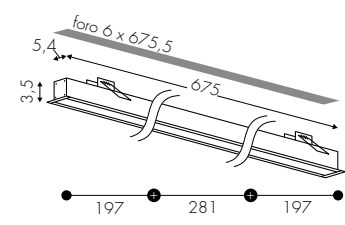

4030OOFBVE2B
4030ODMBVE2B

212W 18060lm - 220V
DALI(Push) 212W 18060lm - 220V

1.435,00 €
1.597,00 €

Configura Configure / Konfigurieren

www.teamitaliailluminazione.it



Opal E19 UGR<19 Prism ● C 4000K

NE



A↑ Alimentatore Incluso in remoto - Remote Power Supply - Fernspeisung enthalten

CODICE COMPLETO • COMPLETE CODE • VOLLSTÄNDIGE CODE

4030LOF **BV** **E2** **B**

Codice
Code

Finitura
Finishing
Lackierung

Diffusore
Diffuser
Diffusor

Tonalità
Hue
Farbton

configurazione standard: / basic configuration: / Standard Konfiguration:

E2 Opale

● B 3000K

BV

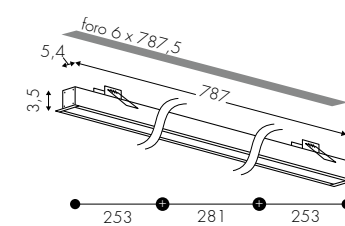

4030POFBVE2B
4030PDMBVE2B

246W 21070lm* - 220V
DALI(Push) 246W 21070lm - 220V

1.744,00 €
1.941,00 €

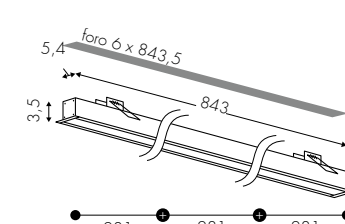

4030QOFBVE2B
4030QDMBVE2B

264W 22575lm - 220V
DALI(Push) 264W 22575lm - 220V

1.838,00 €
1.979,00 €

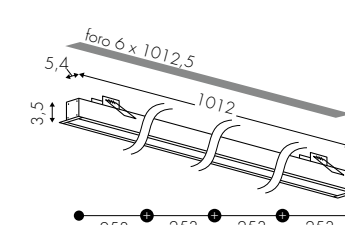

4030ROFBVE2B
4030RDMBVE2B

317W 27090lm - 220V
DALI(Push) 317W 27090lm - 220V

2.195,00 €
2.561,00 €

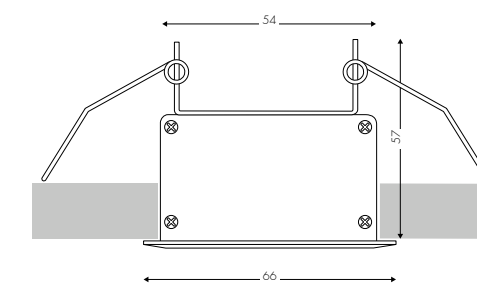

Configura Configure / Konfigurieren

www.teamitaliailluminazione.it



Opal E19 UGR<19 Prism ● C 4000K

NE



A↑ Alimentatore Incluso in remoto - Remote Power Supply - Fernspeisung enthalten

* 21070lm effettivi - effective - effektive con - with - mit **E2**
24780lm effettivi - effective - effektive con - with - mit **E19** **+17,5%**



MIRÓ INCASSO

INCASSO
RECESSED LIGHT
EINBAULEUCHTE



configurazione standard: / basic configuration: / Standard Konfiguration:

E2 Opale

● B 3000K

BV

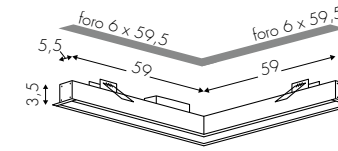

4030KGAOFBVE2B 35W 3010lm* - 220V **430,00 €**
4030KADMBVE2B DALI(Push) 35W 3010lm - 220V **495,00 €**

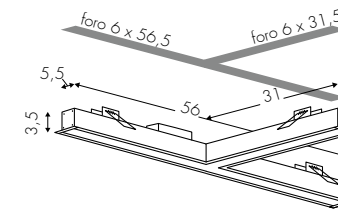

4030KGTFOBVE2B 26W 2250lm - 220V **535,00 €**
4030KGTDMBVE2B DALI(Push) 26W 2250lm - 220V **602,00 €**

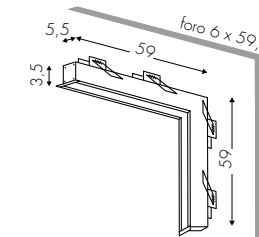

4030KGVOFBVE2B 35W 3010lm - 220V **430,00 €**
4030KGVDMBVE2B DALI(Push) 35W 3010lm - 220V **495,00 €**

Configura

Configure / Konfigurieren

www.teamitaliailluminazione.it



Opal **E19** UGR<19 Prism C 4000K

NE

CODICE COMPLETO DEL PRODOTTO NELLA FOTO
FULL PRODUCT CODE AS SHOWN IN PICTURE - VOLLSTÄNDIGER CODE VOM ARTIKEL IM BILD

4030KGAOF **BV** **E2** **B**

Codice
Code

Finitura
Finishing
Lackierung

Diffusore
Diffuser
Diffusor

Tonalità
Hue
Farbton

Alimentatore Incluso in remoto - Remote Power Supply - Fernspeisung enthalten

* 3010lm effettivi - effective - effektive con - with - mit **E2**
 3540lm effettivi - effective - effektive con - with - mit **E19** **+17,5%**

Sistema binario 48V
Track system 48V
Gleis 48V



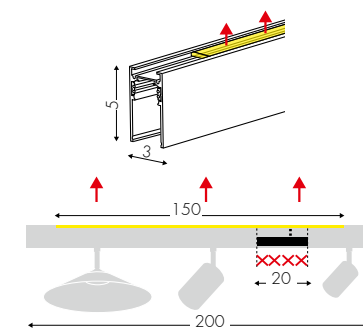

9074U48

Uplight track sospensione 48V DC (2mt) - 33W 4000lm
 Uplight suspension track 48V DC (2mt) - 33W 4000lm

248,00 €

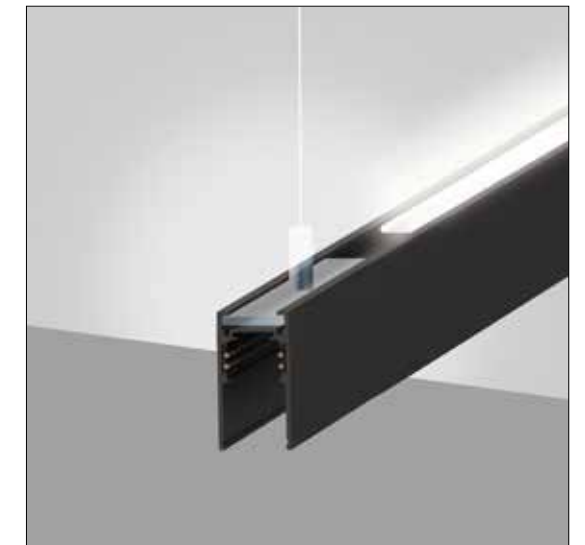

CODICE COMPLETO • COMPLETE CODE • VOLLSTÄNDIGE CODE

9074U48 **NE**

Codice
Code

Finitura
Finishing
Lackierung

SISTEMA B48



configurazione standard: / basic configuration: / Standard Konfiguration:

E2 Opale - Opal - Opal

B 3000K



T1082A48BVE2B

6,5W 680lm* - 48VDC

310,00 €



T3082A48BVE2B

6,5W 680lm - 48VDC

310,00 €



0074A2

Servizio doppia accensione
Dual switch service - Service Doppelzündung

50,00 €

C005T2NE

Custom black cable

8,00 € /MT

Configura



Configure / Konfigurieren

www.teamitaliailluminazione.it



A

A 2700K



CODICE COMPLETO DEL PRODOTTO NELLA FOTO
FULL PRODUCT CODE AS SHOWN IN PICTURE - VOLLSTÄNDIGER CODE VOM ARTIKEL IM BILD

T3082A48 **NE** **E2** **B**

Codice
Code

Finitura
Finishing
Lackierung

Diffusore
Diffuser
Diffusor

Tonalità
Hue
Farbton

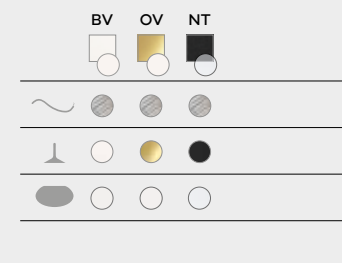

TF Taglio di Fase - Phase-Cut Dimmer - Phasenabschnittdimmer

A Alimentatore nel rosone - Power Supply inside the ceiling rose - Netzteil in der Deckendose

* 680lm effettivi - effective - effektive con - with - mit **E2**

SISTEMA B48

LAMBDA 

configurazione standard: / basic configuration: / Standard Konfiguration:

E19 Prismatico - Prism

 B 3000K



T071A48ONE19B

6.5W 800lm* - 48V DC

292,00 €

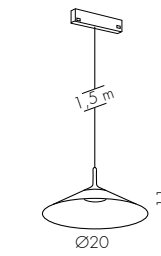

T071B48ONE19B

6.5W 800lm - 48V DC

372,00 €

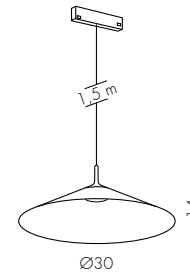

T071F48ONE19B

6.5W 800lm - 48V DC

292,00 €



T071G48ONE19B

6.5W 800lm - 48V DC

372,00 €

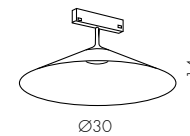

0074A2

Servizio doppia accensione
Dual switch service - Service Doppelzündung

50,00 €

Configura 

Configure / Konfigurieren

www.teamitaliailluminazione.it 



 Alimentatore non incluso - Power Supply not included - Netzteil nicht enthalten

* 800lm effettivi - effective - effektive con - with - mit E19



 CODICE COMPLETO DEL PRODOTTO NELLA FOTO
FULL PRODUCT CODE AS SHOWN IN PICTURE - VOLLSTÄNDIGER CODE VOM ARTIKEL IM BILD

T071A48

Codice
Code

ZN

Finitura
Finishing
Lackierung

E19

Diffusore
Diffuser
Diffusor

B

Tonalità
Hue
Farbton

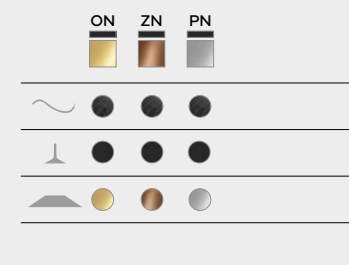

SISTEMA B48

LICIS 



configurazione standard: / basic configuration: / Standard Konfiguration:

E2 Opale - Opal

 B 3000K

NT 

T073A48NTE2B

6.5W 800lm* - 48V DC

350,00 €

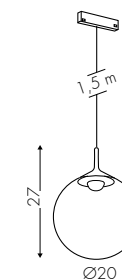

T073F48NTE2B

6.5W 800lm - 48V DC

350,00 €

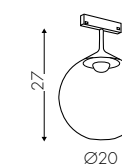

0074A2

Servizio doppia accensione
Dual switch service - Service Doppelzündung

50,00 €

Configura 

Configure / Konfigurieren

www.teamitaliailluminazione.it 



E2 Opale - Opal

 B 3000K

NF 

 **CODICE COMPLETO DEL PRODOTTO NELLA FOTO**
FULL PRODUCT CODE AS SHOWN IN PICTURE - VOLLSTÄNDIGER CODE VOM ARTIKEL IM BILD

T073A48

NF

E2

B

Codice
Code

Finitura
Finishing
Lackierung

Diffusore
Diffuser
Diffusor

Tonalità
Hue
Farbton

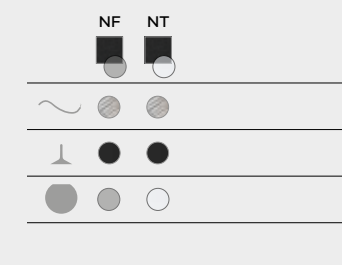

 Alimentatore non incluso - Power Supply not included - Netzteil nicht enthalten

* 800lm effettivi - effective - effektive con - with - mit **E2**





SISTEMA B48

LINEA DARK

configurazione standard: / basic configuration: / Standard Konfiguration:

E19 Prismatico - Prism ● B 3000K

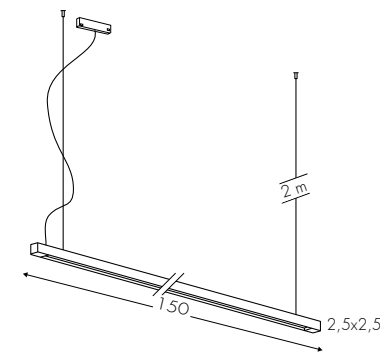

T021A48BVE19B 27W 2320lm* - 48V DC

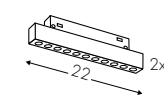

T021F48BVE19B 10W - 900lm - 48VDC

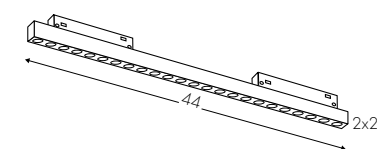

T021G48BVE19B 20W - 1800lm - 48V DC



0074A2 Servizio doppia accensione
Dual switch service - Service Doppelzündung

Configura Configure / Konfigurieren

www.teamitaliailluminazione.it



Alimentatore non incluso - Power Supply not included - Netzteil nicht enthalten

* 2320lm effettivi - effective - effektive con - with - mit **E19**

CODICE COMPLETO DEL PRODOTTO NELLA FOTO
FULL PRODUCT CODE AS SHOWN IN PICTURE
VOLLSTÄNDIGER CODE VOM ARTIKEL IM BILD

T021A48 **NE** **E19** **B**

Codice Code	Finitura Finishing Lackierung	Diffusore Diffuser Diffusor	Tonalità Hue Farbton
----------------	-------------------------------------	-----------------------------------	----------------------------

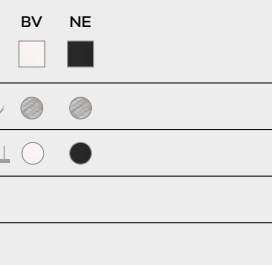

SISTEMA B48

MELLOW 



configurazione standard: / basic configuration: / Standard Konfiguration:

E2 Opale - Opal - Opal

 B 3000K

BV 

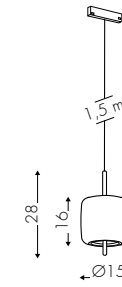

T1083A48BVE2B

6,5W 1000lm* - 48VDC

370,00 €

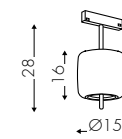

T3083A48BVE2B

6,5W 1000lm - 48VDC

370,00 €



0074A2

Servizio doppia accensione
Dual switch service - Service Doppelzündung

50,00 €

 C005T2NE

Custom black cable

8,00 € /MT

Configura 

Configure / Konfigurieren

www.teamitaliailluminazione.it 



 A 2700K



 **CODICE COMPLETO DEL PRODOTTO NELLA FOTO**
FULL PRODUCT CODE AS SHOWN IN PICTURE - VOLLSTÄNDIGER CODE VOM ARTIKEL IM BILD

T3083A48 **BV** **E2** **B**

Codice
Code

Finitura
Finishing
Lackierung

Diffusore
Diffuser
Diffusor

Tonalità
Hue
Farbton

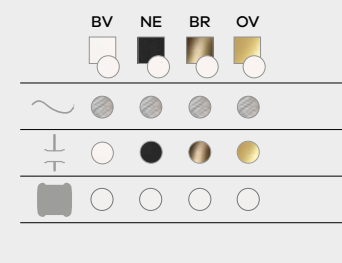

TF Taglio di Fase - Phase-Cut Dimmer - Phasenabschnittdimmer

A Alimentatore nel rosone - Power Supply inside the ceiling rose - Netzteil in der Deckendose

* 1000lm effettivi - effective - effektive con - with - mit **E2**

SISTEMA B48



RV custom finish

configurazione standard: / basic configuration: / Standard Konfiguration:

E28 Satinato
Frosted - Satiniert

B 3000K

BV

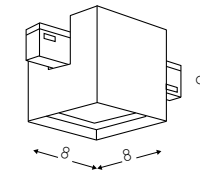

T009A48NEE28B

13W 1000lm* - 48V DC

199,00 €



0074A2

Servizio doppia accensione
Dual switch service - Service Doppelzündung

50,00 €

Configura

Configure / Konfigurieren

www.teamitaliailluminazione.it

NE RU



CODICE COMPLETO DEL PRODOTTO NELLA FOTO
FULL PRODUCT CODE AS SHOWN IN PICTURE - VOLLSTÄNDIGER CODE VOM ARTIKEL IM BILD

T009A48 **RV** **E28** **B**

Codice
Code

Finitura
Finishing
Lackierung

Diffusore
Diffuser
Diffusor

Tonalità
Hue
Farbton

Alimentatore non incluso - Power Supply not included - Netzteil nicht enthalten

* 1000lm effettivi - effective - effektive con - with - mit **E28**

SISTEMA B48

SHADOW 



configurazione standard: / basic configuration: / Standard Konfiguration:

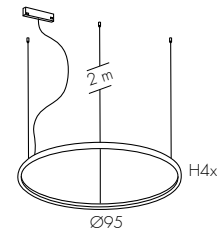
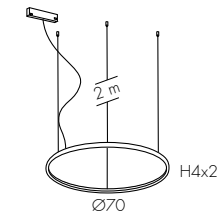

E2 Opale - Opal B 3000K BF BV

T068B48BVE2B 49W 3440lm* - 48V DC **595,00 €**

T068C48BVE2B 66W 5630lm - 48V DC **695,00 €**

[Configura](#)  Configure / Konfigurieren

www.teamitaliailluminazione.it 



configurazione standard: / basic configuration: / Standard Konfiguration:

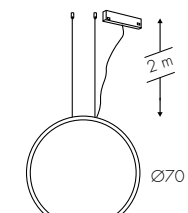
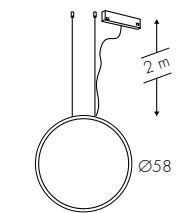

E2 Opale - Opal B 3000K BV

T068O48BVE2B 39W 2680lm - 48V DC **520,00 €**

T068E48BVE2B 49W 3440lm - 48V DC **695,00 €**

O074A2 Servizio doppia accensione / Dual switch service - Service Doppelzündung **50,00 €**

[Configura](#)  Configure / Konfigurieren

www.teamitaliailluminazione.it 



 **CODICE COMPLETO DEL PRODOTTO NELLA FOTO**
FULL PRODUCT CODE AS SHOWN IN PICTURE - VOLLSTÄNDIGER CODE VOM ARTIKEL IM BILD

T068E48 **OV** **E2** **B**

Codice Code	Finitura Finishing Lackierung	Diffusore Diffuser Diffusor	Tonalità Hue Farbton
----------------	-------------------------------------	-----------------------------------	----------------------------

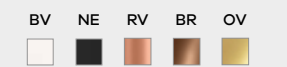

 Alimentatore non incluso - Power Supply not included - Netzteil nicht enthalten

* 3440lm effettivi - effective - effektive con - with - mit **E2**

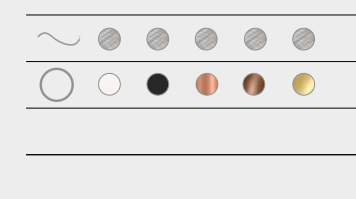

SISTEMA B48

SPOTLIGHT 



configurazione standard: / basic configuration: / Standard Konfiguration:

24° Ottica - Optic - Optik ● B 3000K

BV

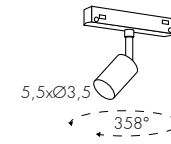

T018B48BV24B 4W 380lm* 48V DC

128,00 €

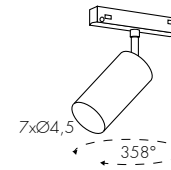

T018C48BV24B 7W 550lm 48V DC

131,00 €

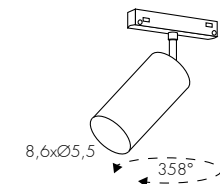

T018D48BV24B 12W 850lm 48V DC

145,00 €

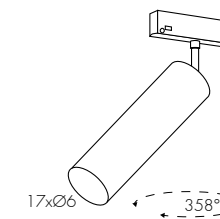

T018E48BV24B 18W 1280lm 48V DC

193,00 €



0074A2 Servizio doppia accensione
Dual switch service - Service Doppelzündung

50,00 €

[Configura](#)  Configure / Konfigurieren

www.teamitaliailluminazione.it 



NE

 Alimentatore non incluso - Power Supply not included - Netzteil nicht enthalten

* 380lm effettivi - effective - effektiven con - with - mit 24°

 **CODICE COMPLETO DEL PRODOTTO NELLA FOTO**
FULL PRODUCT CODE AS SHOWN IN PICTURE - VOLLSTÄNDIGER CODE VOM ARTIKEL IM BILD

T018C48 **NE** **24** **B**

Codice
Code

Finitura
Finishing
Lackierung

Diffusore
Diffuser
Diffusor

Tonalità
Hue
Farbton

SISTEMA B48

TUBÍCO 



configurazione standard: / basic configuration: / Standard Konfiguration:

E8 Trasparente - Transparent  B 3000K 

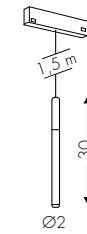

T069A48ONE8B

3W 350lm* - 48V DC

235,00 €



T069B48ONE8B

3W 350lm - 48V DC

252,00 €

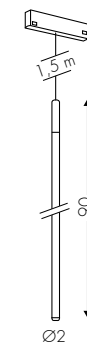

T069C48ONE8B

3W 350lm - 48V DC

265,00 €



0074A2

Servizio doppia accensione
Dual switch service - Service Doppelzündung

50,00 €

Configura 

Configure / Konfigurieren

www.teamitaliailluminazione.it 



E19 

 Alimentatore non incluso - Power Supply not included - Netzteil nicht enthalten

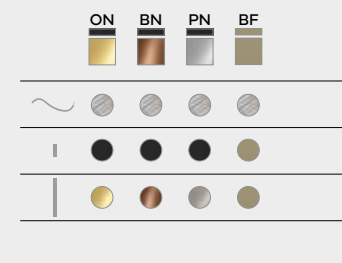

* 350lm effettivi - effective - effektiven con - with - mit **E8**

standard

optional



E8



E19

 **CODICE COMPLETO DEL PRODOTTO NELLA FOTO**
FULL PRODUCT CODE AS SHOWN IN PICTURE
VOLLSTÄNDIGER CODE VOM ARTIKEL IM BILD

T069B48 **ZN** **E19** **B**

Codice
Code

Finitura
Finishing
Lackierung

Diffusore
Diffuser
Diffusor

Tonalità
Hue
Farbton

SISTEMA B48

VENIS 



configurazione standard: / basic configuration: / Standard Konfiguration:

E2 Opale
Opal - Opal

 B 3000K

NT 

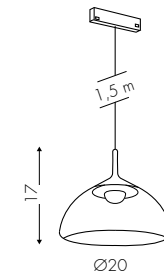

T064A48NTE2B

6.5W 800lm* - 48V DC

350,00 €

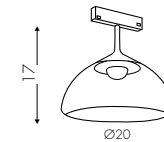

T064F48NTE2B

6.5W 800lm - 48V DC

350,00 €



0074A2

Servizio doppia accensione
Dual switch service - Service Doppelzündung

50,00 €

Configura 

Configure / Konfigurieren

www.teamitaliailluminazione.it 



 **CODICE COMPLETO DEL PRODOTTO NELLA FOTO**
FULL PRODUCT CODE AS SHOWN IN PICTURE - VOLLSTÄNDIGER CODE VOM ARTIKEL IM BILD

T064A48

NF

E2

B

Codice
Code

Finitura
Finishing
Lackierung

Diffusore
Diffuser
Diffusor

Tonalità
Hue
Farbton

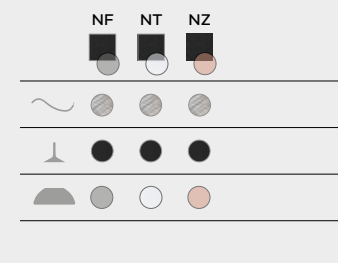

 Alimentatore non incluso - Power Supply not included - Netzteil nicht enthalten

* 800lm effettivi - effective - effektiven con - with - mit **E2**



Sistemi di Gestione della luce
Light Management Systems
Lichtsteuersysteme



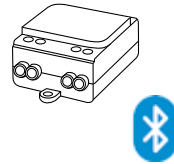

9010BTMD

Dispositivo Bluetooth per rendere dimmerabili Wireless da remoto i nostri prodotti in versione "DM" (DALI).
Our products DM dimmable (DALI) products are compatible with Tridonic module for remote bluetooth dimming.

Bluetooth-Gerät, um unsere "DM" (DALI) Produkte Wireless dimmbar zu machen.

163,00 €

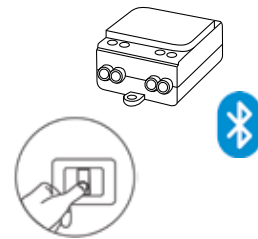

9010BTPD

Dispositivo per rendere Bluetooth un pulsante normalmente aperto.

Device to make Bluetooth a button normally open.

Gerät, um Bluetooth zu einer normalweise geöffneten Taste zu machen.

163,00 €

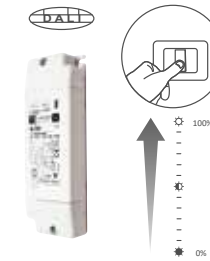
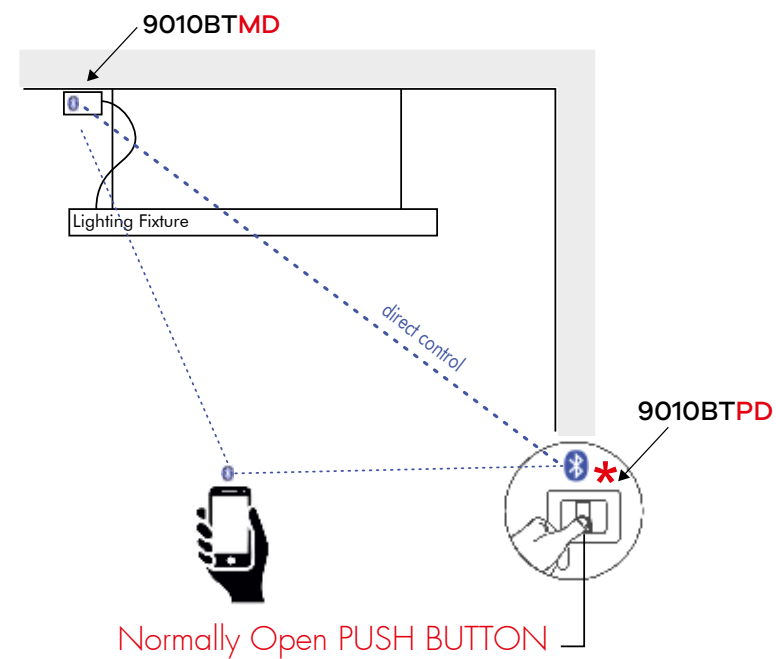

Max 10A 12/24VDC

90106002

Dispositivo per la gestione di sorgenti led a luce monocromatica con Pulsante o con sistema Domotico DALI.

Monochromatic led light manager with button or DALI domotic system.

Gerät für die Verwaltung von monochromatischem Led-Lichtquellen mit Druckknopfschaltung oder DALI Domotik.

79,00 €

Dispositivi necessari - Necessary devices - Notwendige Geräte



CODICE COMPLETO • COMPLETE CODE • VOLLSTÄNDIGE CODE

9010BTMD

Codice
Code

CODICE COMPLETO • COMPLETE CODE • VOLLSTÄNDIGE CODE

90106002

Codice
Code

Accessori
Accessoires
Zubehör

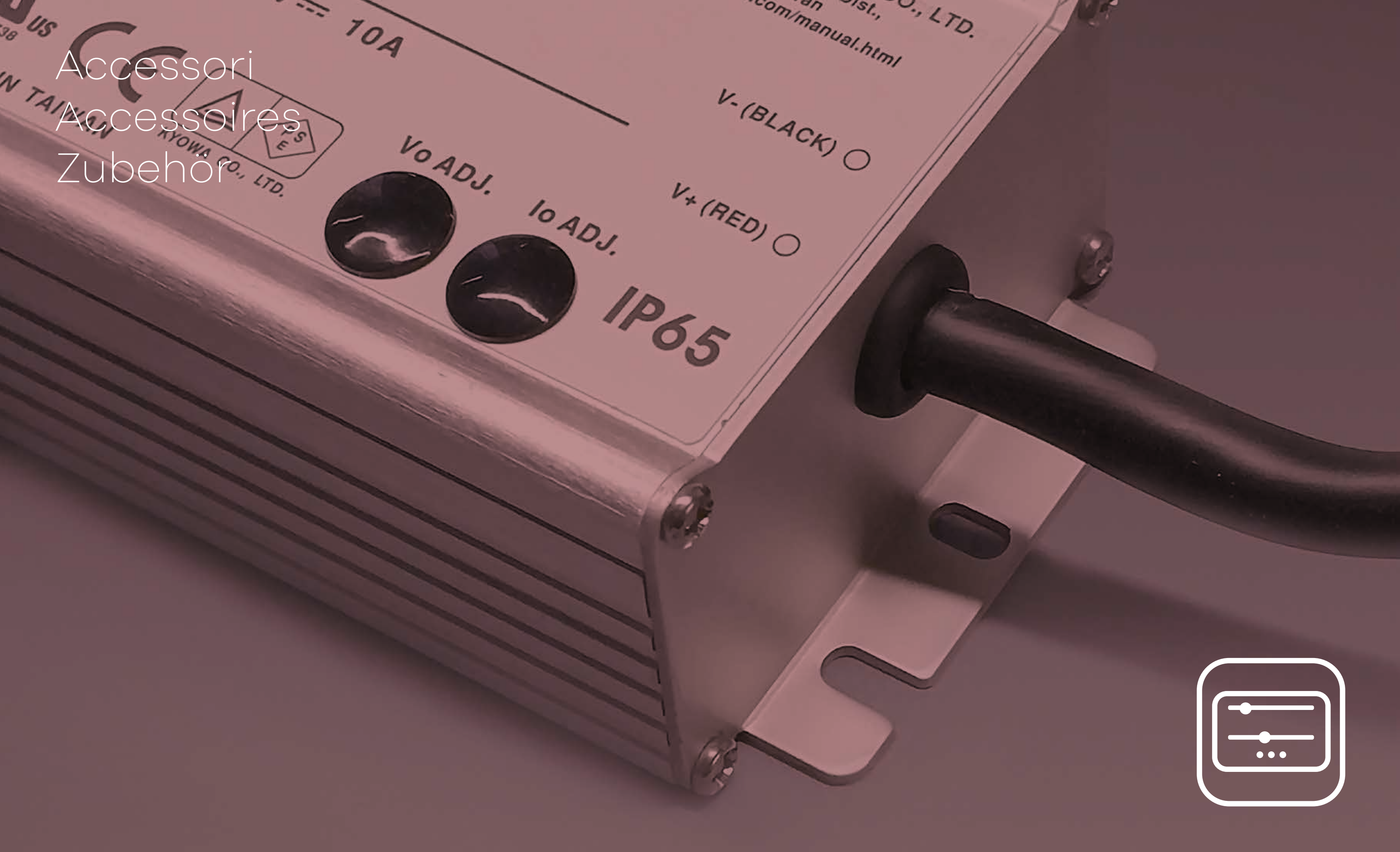

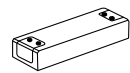

ON/OFF

AE006A	Driver 10W - On/Off 350mA / 35V / IP20	16,00 €
AE006B	Driver 16W - On/Off 350mA / 12-44V / IP20	28,00 €
AE006C	Driver 35W - On/Off 500mA / 50-100V IP20	26,00 €
AE006D	Driver 9W - On/Off 250mA / 5-36V IP20	22,00 €
AE006E	Driver 6W - On/Off 150mA / 5-40V IP20	22,00 €
AE006F	Driver 20W - On/Off 500mA / 12-44V IP20	27,00 €
AE006G	Driver 24W - On/Off 200-700mA / 3-42V IP20	35,00 €
AE006H	Driver 30W - On/Off 700mA / 20-42V IP20	31,00 €
AE006I	Driver 4W - On/Off 350mA / 3-12V / IP65	13,00 €
AE006L	Driver 10W - On/Off 350mA / 2-28,5V IP65	100,00 €
AE006M	Driver 18W - On/Off 350mA / 2-49V IP65	59,00 €
AE006N	Driver 34W - On/Off 300-700mA / IP20	30,00 €
AE006O	Driver 15W - On/Off 350-725mA / IP20	32,00 €

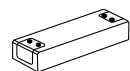

TRIAC

AE007F	Driver 25W - Triac 250-700mA / 15-49V IP20	56,00 €
AE008A	Driver 10W - Triac 350mA / 12-28V IP20	26,00 €
AE008B	Driver 18W - Triac 350mA / 25-51V IP20	26,00 €
AE008C	Driver 40W - Triac 350mA / 53-108V IP20	24,00 €
AE008D	Driver 10W - Triac 350mA / 3-42V IP20	18,00 €
AE008E	Driver 21W - Triac 300-500mA / 28-42V IP20	24,00 €
AE008F	Driver 20W - Triac 150-700mA / 7-44V IP20	44,00 €
AE008G	Driver 20W - Triac 180-350mA / 28-42V IP20	25,00 €
AE008H	Driver 20W - Triac 250-900mA / 15-48V IP20	46,00 €

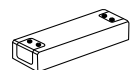

DALI (Push)

AE007A	Driver 30W - DALI(Push) 250-700mA / 2-54V IP20	65,00 €
AE007B	Driver 25W - DALI(Push) 350-1050mA / 20-50V IP20	62,00 €
AE007C	Driver 10W - DALI(Push) 150-400mA / 15-40V IP20	55,00 €
AE007E	Driver 38W - DALI(Push) 300-1050mA / 10-54V IP20	58,00 €

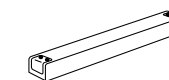

24V ON/OFF

AE003A	Driver 30W - On/Off 24V / IP20	29,00 €
AE003B	Driver 75W - On/Off 24V / IP20	45,00 €
AE003C	Driver 100W - On/Off 24V / IP65	74,00 €
AE003D	Driver 150W - On/Off 24V / IP65	98,00 €
AE003E	Driver 240W - On/Off 24V / IP65	127,00 €
AE003F	Driver 36W - On/Off 24V / IP20	34,00 €
AE003G	Driver 75W - On/Off 24V / IP65	52,00 €
AE003H	Driver 60W - On/Off 24V / IP20	38,00 €
AE003I	Driver 30W - On/Off 24V / IP65	47,00 €

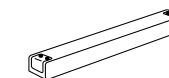

24V DALI

AE004A	Driver 150W - DALI (No-Push) 24V / IP65	113,00 €
---------------	---	-----------------

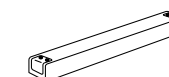

24V TRIAC

AE005A	Driver 100W - Triac 24V / IP20	124,00 €
AE005B	Driver 200W - Triac 24V / IP65	198,00 €

NEW

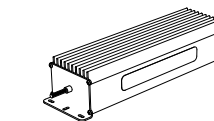

48V TRIAC

AE016A	Driver 100W - Triac 48V / IP65	230,00 €
AE016B	Driver 150W - Triac 48V / IP65	300,00 €

NEW



CODICE COMPLETO • COMPLETE CODE • VOLLSTÄNDIGE CODE

























AE006I







Codice
Code





CODICE COMPLETO • COMPLETE CODE • VOLLSTÄNDIGE CODE





AE003A

Codice
Code



	Superiore diffusa Diffused uplight Obere verbreitung		Inferiore dominante + Superiore diffusa Diffused main emission downlight + Uplight Geringere hauptunterdiffusion + Obere verbreitung
	Superiore asimmetrica diffusa Diffused asymmetrical uplight Obere asymmetrisch verbreitung		Superiore diffusa + Inferiore concentrata Diffused uplight + Diffused downlight Obere verbreitung + Geringere konzentriertes
	Superiore concentrata Accent uplight Obere konzentriertes		Inferiore diffusa + Superiore asimmetrica concentrata Diffused Downlight + Accent asymmetrical uplight Geringere verbreitung + Obere asymmetrisch konzentriertes
	Superiore asimmetrica concentrata Accent asymmetrical uplight Obere asymmetrisch konzentriertes		Superiore concentrata + Inferiore concentrata Accent uplight + Accent downlight Obere konzentriertes + Geringere konzentriertes
	Inferiore diffusa Diffused downlight Geringere verbreitung		Superiore + Inferiore + Frontale diffusa Diffuse up + down + frontal light Obere + Geringere + front verbreitung
	Inferiore asimmetrica diffusa Accent asymmetrical downlight Geringere asymmetrisch verbreitung		Inferiore + Laterale diffusa Diffused side + Downlight Obere asymmetrisch konzentriertes
	Inferiore concentrata Accent downlight Geringere konzentriertes		360° diffusa Diffused all side light Auf vier seiten diffuses
	Inferiore asimmetrica concentrata Accent asymmetrical downlight Geringere asymmetrisch konzentriertes		Orientabile diffusa Diffused adjustable Verstellbar verbreitung
	Frontale diffusa Diffuse frontlight Diffuse front		Orientabile concentrata Accent adjustable Verstellbar konzentriertes
	Superiore diffusa + Inferiore diffusa Diffuse up-downlight Oben-unten diffusion		Orientabile concentrata + Superiore diffusa Accent adjustable + Diffuse up Verstellbar konzentriertes + Obere
	Indiretta posteriore Indirect back Indirektes Heck		Laterale asimmetrico Lateral Asymmetric Seitliche asymmetrische
	Indiretta posteriore + frontale Indirect back + front Indirektes Heck + Front		Laterale simmetrica Lateral symmetric Seitlich symmetrisch

	Indica che un prodotto può circolare liberamente all'interno dell'Unione Europea: Certifica che il prodotto risponde ai requisiti essenziali di sicurezza. Indicates that the product can circulate freely within the European Union: Certifies that the product meets the essential safety requirements. Gibt an, dass ein Produkt innerhalb der Europäischen Union frei im Umlauf sein kann: Bescheinigt, dass das Produkt den wesentlichen Sicherheitsanforderungen entspricht.
	Contatto a terra. Apparecchio in classe prima dotato solo dell'isolamento. Ground contact. Fixture in first class equipped only with insulation. Erdung Gerät in Klasse 1 nur mit Isolierung ausgerüstet.
	Classe II doppio isolamento e/o isolamento rinforzato senza dispositivo di messa a terra. Double insulation and/or reinforced insulation in every part and without ground devices. Doppelte Isolierung, bzw verstärkte Isolierung der Teile, ohne Vorrichtung für Erdung.
	Classe di protezione III - Apparecchi con bassa tensione protettiva. Apparecchi con protezione dallo shock elettrico attraverso la bassa tensione protettiva e che non funzionano con tensioni superiori. Protection class III - Devices with extra-low voltage. Devices with protection from electric shock through the low-voltage protection. They don't work with higher voltages. Schutzklasse III - Leuchten mit Kleinspannung. Geräte mit Schutz vor Stromschlag durch die Niederspannung. Sie arbeiten nicht mit höheren Spannungen.
	Apparecchio adatto al montaggio su superfici normalmente infiammabili. Suitable for mounting on normally inflammable surface. Das Gerät ist zur Installation auf entflammable Oberflächen geeignet.
	Protezione contro corpi estranei di medie dimensioni, nessuna protezione contro la penetrazione di acqua. Protection against medium-sized foreign bodies, no protection against water penetration. Schutz gegen mittelgroße Fremdkörper, ohne Schutz gegen Eindringen von Wasser.
	Protetto contro la polvere. Protetto da spruzzi di ogni tipo. Protected from dust ingress. Protected from water spray from any direction. Staubgeschützt. Schutz gegen Spritzwasser.
	Totalmente protetto contro la polvere. Protetto contro i getti d'acqua con lanci da tutte le direzioni. Protected from total dust ingress. Protected from high pressure water jets from any direction. Staubdicht. Schutz gegen starkes Strahlwasser.
	Totalmente protetto contro la polvere. Protetto contro le ondate. Protected from total dust ingress. Protected from high pressure water jets from any direction. Staubdicht. Schutz gegen starkes Strahlwasser.
	Totalmente protetto contro la polvere. Protetto contro gli effetti di immersione. Protected from total dust ingress. Protected from waves. Staubdicht. Schutz gegen eintauchen.
	Protetto contro energia d'urto 2J. Protected against impact energy 2J. Geschützt gegen Aufprallenergie 2J.
	Protetto contro energia d'urto 5J. Protected against impact energy 5J. Geschützt gegen Aufprallenergie 5J.

-  A 2700K
-  B 3000K
-  C 4000K
-  D 2700K-6500K
-  E RGB

-  Alimentatore Incorporato
Incorporated Power Supply
Eingebautes Netzteil
-  Alimentatore nel rosone
Power Supply inside the ceiling rose
Netzteil in der Deckendose
-  Alimentatore Incluso in remoto
Included Power Supply in remote
Einbezogen Netzteil
-  Alimentatore non incluso
Power Supply not included
Netzteil nicht inbegriffen
-  Sorgente GU10 non inclusa
GU10 light source not included
GU10 lichtquelle nicht einbezogen
-  Sorgente E27 non inclusa
E27 light source not included
E27 Lichtquelle nicht Enthalten

CAVO ALIMENTAZIONE
ELECTRIC CABLE - STROMKABEL

-  Nero - Black - Schwarz
-  Rosso - Red - Rot
-  Bianco - White - Weiß

-  Trasparente - Transparent - Transparent

-  **BV** Bianco
White
Weiß
-  **NE** Nero
Black
Schwarz
-  **RU** Ruggine
Rust
Rost
-  **BF** Bronzo francese
French bronze
Französische Bronze
-  **OS** Oro spazzolato
Brushed Gold
Gebürstetes Gold
-  **OV** Oro verniciato
Painted gold
Gold lackiert
-  **RV** Rame verniciato
Painted copper
Kupfer lackiert
-  **BR** Bronzo
Bronze
Bronze
-  **NT** Nero + Vetro trasparente
Black + Clear glass
Schwarz + Transparentem Glas
-  **SV** Salvia
Sage
Salbei
-  **ZN** Nero + Bronzo
Black + Bronze
Schwarz + Bronze
-  **OB** Oro verniciato + Bianco
Brushed Gold + White
Gebürstetes Gold + Weiß
-  **ON** Oro verniciato + Nero
Brushed Gold + Black
Gebürstetes Gold + Schwarz
-  **RN** Rame verniciato + Nero
Painted copper + Black
Kupfer lackiert + Schwarz
-  **BN** Nero + Bianco
Black + White
Schwarz + Weiß
-  **AB** Argento + Bianco
Silver + White
Silber + Weiß
-  **AB** Argento + Nero
Silver + Black
Silber + Schwarz
-  **PN** Platino + Nero
Platin + Black
Platin + Schwarz
-  **NF** Nero + Vetro fumè
Black + Smoky glass
Schwarz + Rauchglas
-  **BY** Blu Navy
Navy Blue
Blu Navy
-  **SN** Salvia + Nero
Sage + Black
Salbei + Schwarz
-  **CB** Cromo + Bianco
Chrome + White
Chrom + Weiß
-  **BO** Bianco + Ocre
White + Ochre
Weiß + Ocker
-  **BS** Bianco + Salvia
White + Sage
Weiß + Salbei
-  **BB** Bianco + Blu Navy
White + Navy Blue
Weiß + Blu Navy
-  **AL** Alluminio
Aluminium
Aluminium
-  **PL** Platino
Platinum
Platin
-  **GV** Grigio verniciato
Painted Grey
Grau lackiert
-  **NZ** Nero + Vetro bronzo
Black + Bronze glass
Schwarz + Glas bronze
-  **OC** Ocre
Ochre
Ocker



via dell'Artigianato, 21
37066 Caselle di Sommacampagna - Verona (Italy)
Tel. +39 045 8581640
info@teamitaliailluminazione.it
teamitaliailluminazione.it

